

Garden sauna

LAVA

345 x 234 x 260 cm

ASSEMBLY INSTRUCTIONS

English

EN

DE

FR

IT



Table of Contents

1. Preparing for installation	3
1.1. Important note	3
1.2. Foundation	4
1.3. Anchoring the outdoor sauna	4
1.4. Tools required	4
1.5. Maintenance and cleaning	6
1.6. Disposal	6
2. Floor plan / foundation	7
3. Assembling the cabin	8
3.1. Assembling the base frame	8
3.2. Assembling the cabin walls	8
3.3. Mounting the door	8
3.4. Mounting the windows	8
3.5. Assembling the walls	8
3.6. Mounting the pent roof	9
3.7. Assembling the threaded rods	9
3.8. Assembling the sauna roof elements	9
3.9. Installing the outer roof	9
3.10. Covering the roof	9
3.11. Assembling the floor	10
3.12. Installing interior fittings	10
3.13. Mounting the inner door	10
3.14. Installing accessories	10
Dimensional drawing (following the last language of the instructions)	11
Parts list (following the last language of the instructions)	12
Assembly illustrations (following the last language of the instructions)	16

1. Preparing for installation

Read these assembly instructions carefully and keep them within reach. So that you can look up product information at any time.



These assembly instructions can also be found in the downloads section of our website: www.sentiotec.com/downloads.

1.1. Important note

- Check with your local planning authority (municipal office, magistrate) with respect to the building regulations and load standards.
- A solid concrete foundation is important for the durability as well as the safety of your outdoor sauna. We recommend having the foundation laid by a specialist.
- The anchoring of the outdoor sauna is the responsibility of the customer. No warranty in the event of damage.
- The outdoor sauna is delivered by lorry (also possible by semi-trailer truck). Access to the unloading area must be ensured.
- Before you begin work, check the parts list to ensure that all the individual parts have been delivered. If you discover any missing parts, notify your dealer within 14 days of receiving the sauna cabin.
- Keep the delivery note, the invoice and the assembly instructions in a safe place in case of any questions.
- You need an assistant for the installation.
- All screw fittings must be pre-drilled.



Attention!

The electrical connection may only be performed by a qualified electrician or similarly qualified person.

- The roofing felt included in the scope of delivery serves as an initial roofing. We also recommend covering the roof with bitumen shingles, sheet metal or a suitable foil.
- Wood is a natural product that can swell, shrink or warp, despite good storage. For this reason, some force may be necessary during the installation.

- The wood of the outdoor sauna is untreated. To increase the life expectancy, we recommend painting the outside with a suitable paint to protect the wood.
- The inside of the wooden parts used must not be treated with any paint.

1.2. Foundation

The following foundation elements have proven themselves in practice:

- Foundation slab (base plate)
- Strip foundation

For both types, a foundation that is absolutely flat and load-bearing must be ensured. Only then can the assembly of the outdoor sauna be ensured without any difficulties and with a precise fit.

We recommend using tar tape (moisture barrier) between the base wood and the concrete to prevent moisture from penetrating the wood.

1.3. Anchoring the outdoor sauna

The outdoor sauna must be firmly anchored on the base plate or the strip foundation. Strong winds can exert a powerful force on the garden sauna. To prevent damage to your, or third party, property proper anchoring is essential.

We point out that anchoring the garden sauna is the responsibility of the customer and we do not accept any liability for accidental damage.

1.4. Tools required

- Hammer with a wooden block and a mallet
- Cordless screwdriver with bits for cross-head screws and Torx
- Roller tape measure
- Drill bits with a diameter of 4 mm, 5 mm, 6 mm, 20 - 30 mm (for sauna heater power cable)
- Spirit level
- 17 mm open-ended spanner
- Utility knife
- Ladder
- Saw



This symbol indicates tips and useful information



Pre-drill



Cut to correct size



Nailing



Carry out wiring

EN



Check the right angle:

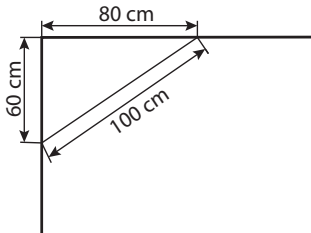

Handle glass with care: Special care must be taken with the edges of the glass – hardened glass can shatter into small pieces in the event of impact. Insert protective cushioning (e.g: cardboard box) under the edge of the glass.

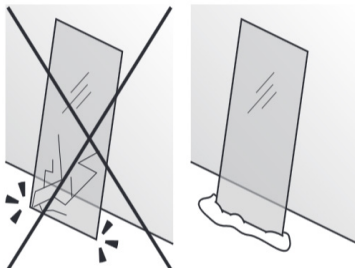

1.5. Maintenance and cleaning

- The sauna should be cleaned inside with a damp cloth. Only use warm water – no cleaning products.
- We recommend heating the cabin once a month if the sauna is not used for a long time.



Pitch pockets are not grounds for return, since they can always appear in spruce wood and the depth at which they lie cannot be detected during the sorting-out process.

If these are just under the surface, heat can cause them to soften and “bleed”.

The leaking pitch can be removed with a rag soaked in acetone. If only droplets of pitch occur, allow these to harden and then carefully scrape them off with a knife.

1.6. Disposal



- Dispose of packaging materials in accordance with the applicable waste disposal regulations.



2. Floor plan / foundation

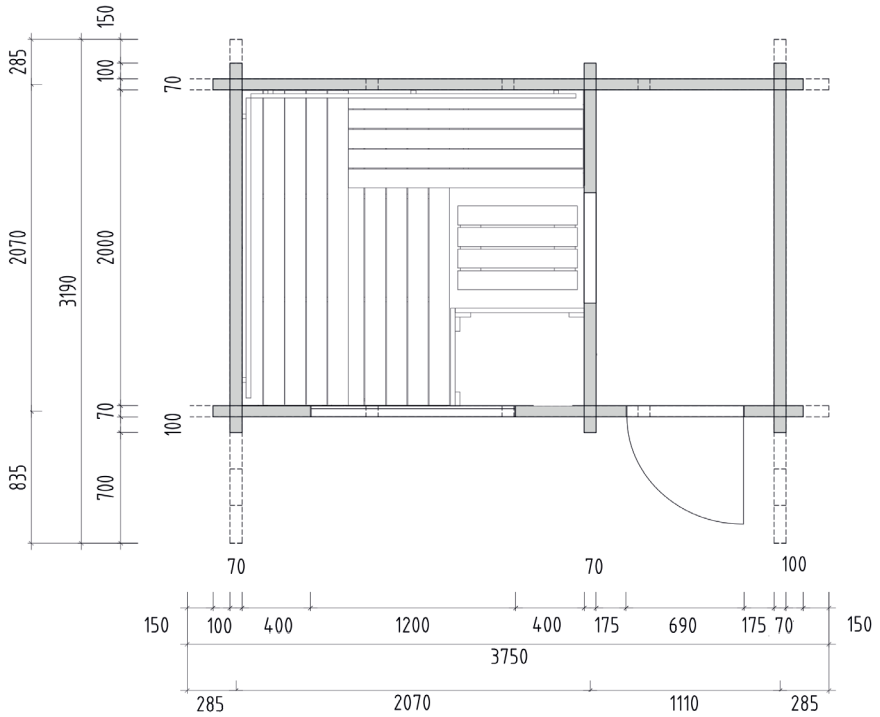

EN

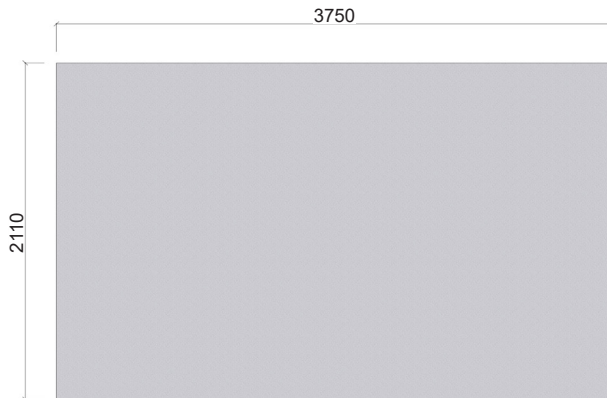

3. Assembling the cabin



ATTENTION!

Note the floor plans on Page 7 and illustrations from Page 11 onwards.

3.1. Assembling the base frame

Place the impregnated base frame on the foundation as shown on the floor plan and the foundation illustrations (see Page 7).



Make sure that the base frame is assembled at right angles.

Note the power supply!

3.2. Assembling the cabin walls



Always put the wall planks together with the tongue facing upwards.

NEVER hit the tongue directly with a hammer!

Start by laying the half planks of the front and back walls on the base frame and then put on the side planks.

Connect the block planks to the concrete foundation at the corners (see 1.3 on page 4).

Continue row by row - up to and including row 7. Note the position of the ventilation slide in row 2 and the block planks with holes for the electrical installation.

3.3. Mounting the door

Push the door frame into the opening from above (door opens outward).

Install the door fitting.

3.4. Mounting the windows

Mount the remaining block planks - up to and including row 12.

First fit the edge strips to the window. Slide the window into the opening from above.

3.5. Assembling the walls

Mount the remaining block planks - up to and including row 18.

Note the position of the block planks with the holes for wiring.

Screw the inner door and window panel at a right angle.

3.6. Mounting the pent roof

Mount the left and right pent roof elements. Remove the upper diagonal block planks to put in the block planks at the front.

3.7. Assembling the threaded rods

Connect the threaded rods with each other as shown in the picture and push them down into the holes provided for them in the block planks.

Screw the flange on the top and fasten the washers and nuts on the bottom.

Then mount the middle pent roof element and its threaded rod.

Prepare the holes for the technical systems (sauna heater, control unit etc.).

3.8. Assembling the sauna roof elements

Install the roof support slats.

Put in the roof elements.



Carry out the electrical installation - pull in the cables!

If the roof elements are screwed together from above, it will not be possible to access the roof space later. An inspection opening for the equipment may then have to be cut in the roof gable.

3.9. Installing the outer roof

Place the rafters in the recesses as illustrated and screw them to the block planks.

Attach the tongue-and-groove boards to the rafters - start at the back. Gently knock the boards together and nail them to the rafters. Make sure the boards are consistently parallel.

The roof boards must be flush with the rafters at the front and back - shorten the boards if necessary.

3.10. Covering the roof

Start laying the roofing felt as illustrated on the lower side of the roof (40 mm overhang).

Mount the roof edge boards and roof edge trims.

3.11. Assembling the floor

Place the floor boards on the floor frame and fasten them to the floor frame.



Make sure that there is 5 mm gap to the walls to allow the wood to expand and contract as the temperature changes.

Shorten the skirting boards to the correct size and fasten them to the block planks - not to the floor boards!

3.12. Installing interior fittings

Mount the ventilation slide.

Assemble the bench support ledges as illustrated.

First put in the upper benches and screw them together.

Place the lower bench on the support ledges.

Fasten the bench screen and backrests as illustrated.

3.13. Mounting the inner door

First mount the edge boards on the door frame (lobby side). Place the inner door into the door opening from the lobby side and fix it by fitting the door panel of the sauna interior.

3.14. Installing accessories

Assemble the light and lamp protection grilles.

Assemble the protection grille.

Assemble the outer ventilation grille.

Gartensauna

LAVA

345 x 234 x 260 cm

MONTAGEANLEITUNG

Deutsch

DE



Inhaltsverzeichnis

1. Montage Vorbereitung	3
1.1. Wichtige Hinweise	3
1.2. Fundament	4
1.3. Verankerung der Außensauna	4
1.4. Benötigtes Werkzeug	4
1.5. Wartung und Reinigung	6
1.6. Entsorgung	6
2. Grundriss / Fundament	7
3. Montage Kabine	8
3.1. Montage Grundrahmen	8
3.2. Montage Kabinenwände	8
3.3. Montage Tür	8
3.4. Montage Fenster	8
3.5. Montage Wände	8
3.6. Montage Pultdach	9
3.7. Montage Gewindestangen	9
3.8. Montage Sauna Dachelemente	9
3.9. Montage Außendach	9
3.10. Dacheindeckung	9
3.11. Montage Boden	10
3.12. Montage Inneneinrichtung	10
3.13. Montage Innentür	10
3.14. Montage Zubehör	10
Abbildung Abmessungen (nach der letzten Sprache)	11
Stückliste (nach der letzten Sprache)	12
Montage Abbildungen (nach der letzten Sprache)	16

1. Montage Vorbereitung

Lesen Sie diese Montageanleitung gut durch und bewahren Sie sie auf. So können Sie jederzeit Produktinformationen nachlesen.



Sie finden diese Montageanleitung auch im Downloadbereich unserer Webseite auf www.sentiotec.com/downloads.

1.1. Wichtige Hinweise

- Erkundigen Sie sich bei Ihrer zuständigen Baubehörde (Gemeindeamt, Magistrat) bezüglich den Bauvorschriften und Belastungsnormen.
- Ein solides Betonfundament ist wichtig für die Haltbarkeit sowie für die Sicherheit Ihrer Außensauna. Wir empfehlen Ihnen das Fundament von einem Fachmann herstellen zu lassen.
- Die Verankerung der Außensauna liegt im Verantwortungsbereich des Kunden. Keine Gewährleistung bei auftretenden Schäden.
- Die Außensauna wird per LKW (eventuell auch per Sattelzug) angeliefert. Dabei muss gewährleistet sein, dass die Zufahrt zum Entladeort möglich ist.
- Kontrollieren Sie, bevor Sie mit der Arbeit beginnen, anhand der Stückliste, ob alle Einzelteile auch tatsächlich mitgeliefert wurden. Sollten Einzelteile ausnahmsweise fehlen, benachrichtigen Sie spätestens 14 Tage nach Erhalt der Kabine Ihren Händler.
- Bewahren Sie den Lieferschein, die Rechnung und die Montageanleitung für eventuelle Rückfragen gut auf.
- Für die Montage benötigen Sie einen Helfer.
- Alle Verschraubungen müssen vorgebohrt werden.



Achtung!

Der Elektroanschluss darf nur durch eine Elektrofachkraft oder eine vergleichsweise qualifizierte Person ausgeführt werden.

- Die im Lieferumfang enthaltene Dachpappe dient als Ersteindeckerung. Wir empfehlen zusätzlich das Dach mit Bitumenschindeln, Blech oder einer geeigneten Folie einzudecken.
- Holz ist ein Naturprodukt, das trotz guter Lagerung aufquellen, schwinden oder sich verziehen kann. Aus diesem Grund kann es vorkommen, dass bei der Montage etwas Kraft aufgebracht werden muss.

- Das Holz der Außensauna ist unbehandelt. Um die Lebensdauer zu erhöhen, empfehlen wir, außen mit einer geeigneten Holzschutzfarbe zu streichen.
- Die Innen zu verwendenden Holzteile dürfen nicht mit Farbe behandelt werden.

1.2. Fundament

Diese folgenden Fundamente haben sich in der Praxis bewährt:

- Fundamentplatte (Bodenplatte)
- Streifenfundament

Dabei ist bei beiden Varianten ein absolut waagrechtes und tragfähiges Fundament zu gewährleisten. Nur so kann eine einwandfreie Montage der Außensauna mit einer exakten Passgenauigkeit gewährleistet werden.

Wir empfehlen, Teerband (Feuchtigkeitssperre) zwischen dem Sockelholz und dem Beton zu verwenden, um zu verhindern, dass Feuchtigkeit in das Holz eindringt.

1.3. Verankerung der Außensauna

Es ist sehr wichtig, dass die Außensauna fest mit der Bodenplatte oder dem Streifenfundament verankert wird. Bei starkem Wind können große Kräfte auf das Gartenhaus einwirken. Um Schäden am eigenen oder fremden Eigentum zu vermeiden ist eine fachgerechte Verankerung unbedingt notwendig.

Wir weisen Sie darauf hin, dass die Verankerung des Gartenhauses im Verantwortungsbereich des Kunden liegt, und wir für auftretende Schäden keine Gewährleistung übernehmen.

1.4. Benötigtes Werkzeug

- Hammer und Beilageholz und einen Gummihammer
- Akkuschauber mit Bits für Kreuzschrauben und Torx
- Rollmaßband
- Bohrer mit Durchmesser 4 mm, 5 mm, 6 mm, 20 - 30 mm (für Stromkabel Saunaofen)
- Wasserwaage
- Gabelschlüssel 17mm
- Universalmesser
- Leiter
- Säge



Dieses Symbol kennzeichnet Tipps und nützliche Hinweise



Vorbohren



Ablängen auf Naturmaß



Annageln



Verkabelung vornehmen



Überprüfung des rechten Winkel:

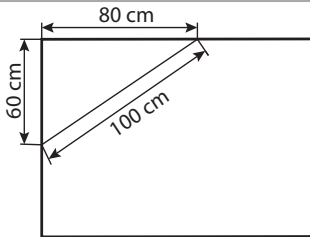

Vorsichtiger Umgang mit Glas: Besondere Vorsicht gilt den Glaskanten - Gehärtetes Glas kann bei Stößen in kleine Scherben zerspringen. Legen Sie ein Schutzpolster (z.Bsp.: Verpackungs-Karton) unter die Glaskante.

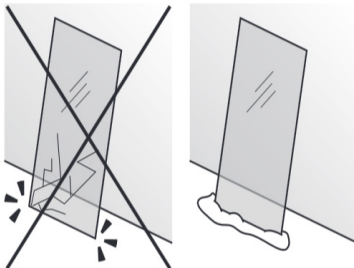

1.5. Wartung und Reinigung

- Die Sauna sollte innen mit einem feuchten Tuch gereinigt werden. Verwenden Sie nur warmes Wasser - keine Reinigungsmittel.
- Wird die Sauna längere Zeit nicht benutzt, empfehlen wir, die Kabine einmal im Monat aufzuheizen.



Harzgallen sind kein Reklamationsgrund. Da in Fichtenholz immer wieder Harzgallen vorkommen und man beim Aussortieren nicht erkennen kann in welcher Tiefe diese sich befinden.

Wenn diese knapp unter der Oberfläche sind brechen sie bei Hitzeentwicklung auf und „bluten“ aus.

Das ausgelaufene Harz kann man mit einem Aceton gedrängtem Lappen entfernen. Wenn lediglich Harztropfen entstehen, lassen Sie diese aushärten und schaben sie anschließend mit einem Messer vorsichtig ab.

1.6. Entsorgung



- Entsorgen Sie die Verpackungsmaterialien nach den gültigen Entsorgungsrichtlinien.



2. Grundriss / Fundament

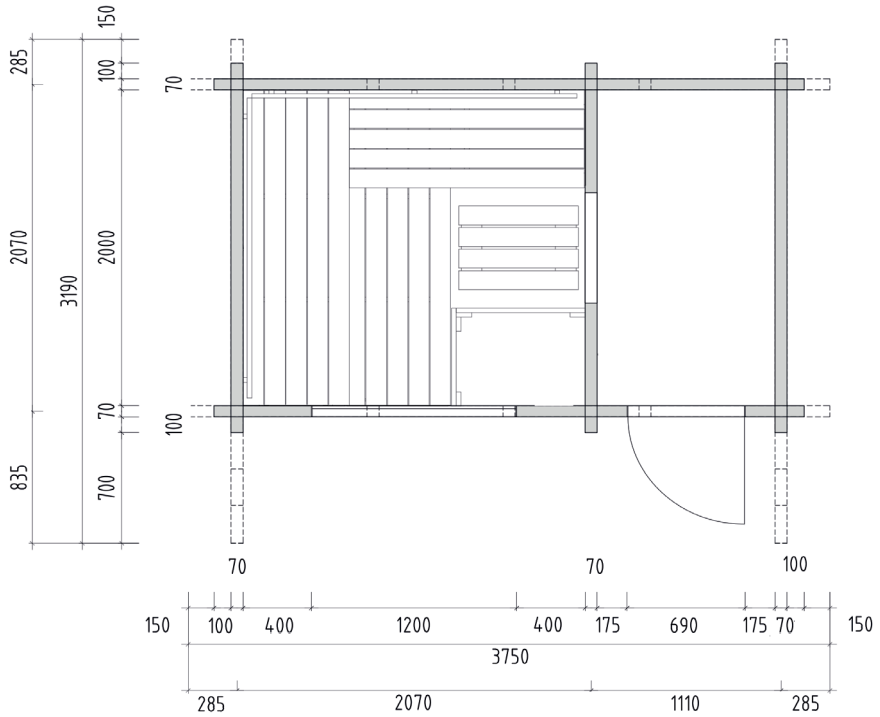

DE

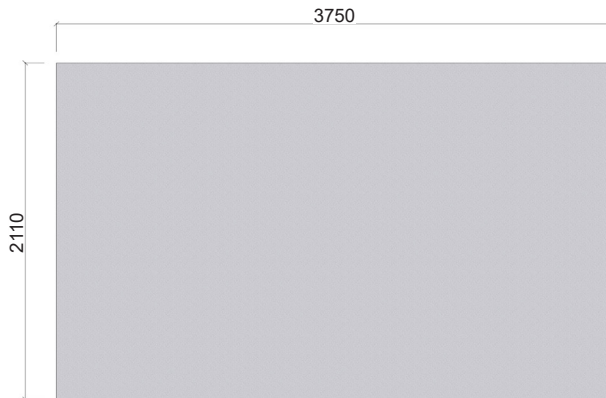

3. Montage Kabine



ACHTUNG!

Beachten Sie den Grundrisse auf Seite 7 und die Abbildungen ab Seite 11.

3.1. Montage Grundrahmen

Legen Sie den imprägnierten Grundrahmen auf das Fundament wie dies im Grundriss und in der Fundament-Darstellungen angezeigt ist (siehe Seite 7).



Beachten Sie, dass der Grundrahmen im rechten Winkel montiert wird. Stromzufuhr beachten!

3.2. Montage Kabinenwände



Die Wandbohlen werden immer mit der Feder nach oben zeigend zusammengesteckt.

Schlagen Sie NIE mit dem Hammer direkt auf die Feder!

Beginnen Sie mit der Verlegung der halben Bohlen der Vorder- und Rückwand auf den Grundrahmen und legen dann die Seitenbohlen auf.

Verbinden Sie die Blockbohlen an den Ecken mit dem Betonfundament (siehe 1.4 auf Seite 4).

Gehen Sie Reihe für Reihe weiter vor - bis einschließlich Reihe 7. Beachten Sie die Position des Lüftungsschiebers in Reihe 2 und der Blockbohlen mit Bohrungen für die Elektroinstallation.

3.3. Montage Tür

Der Türrahmen wird von oben in die Öffnung geschoben (Türöffnung nach außen). Montieren Sie den Türbeschlag.

3.4. Montage Fenster

Montieren Sie die restlichen Blockbohlen - bis einschließlich Reihe 12.

Montieren Sie zuerst die Randleisten an das Fenster. Schieben Sie das Fenster von oben in die Öffnung.

3.5. Montage Wände

Montieren Sie die restlichen Blockbohlen- bis einschließlich Reihe 18.

Beachten Sie die Positionierung der Blockbohlen mit den Bohrungen für die Verkabelung.

Verschrauben Sie die Tür- und Fensterverblendung innen im rechten Winkel.

3.6. Montage Pultdach

Pultdachelemente rechts und links aufstecken. Entfernen Sie die oberen, schrägen Blockbohlen zum Einsetzen der Blockbohlen an der Vorderseite.

3.7. Montage Gewindestangen

Verbinden Sie die Gewindestangen wie abgebildet miteinander und schieben sie von oben in die dafür vorgesehenen Bohrungen der Blockbohlen.

Verschrauben Sie den Flansch an der Oberseite und befestigen Sie die Beilagscheiben und Muttern an der Unterseite.

Dann erfolgt die Montage des mittleren Pultdachelementes und der dazugehörigen Gewindestange.

Bohrungen für Technik (Saunaofen, Steuerung,...) vorbereiten.

3.8. Montage Sauna Dachelemente

Montage der Dachauflageleisten.

Dachelemente einlegen.



Elektroinstallation vornehmen - Kabel einziehen!

Werden die Dachelemente von oben verschraubt, kann man später nicht mehr in den Dachzwischenraum. Für die Technik muss dann ggf. eine Revisionsöffnung in den Dachgiebel geschnitten werden.

DE

3.9. Montage Außendach

Legen Sie die Dachsparren laut Abbildung in die Ausnehmungen und verschrauben diese mit den Blockbohlen.

Befestigen Sie die Nut-Federbretter an den Dachsparren - beginnen Sie an der Hinterseite. Klopfen Sie die Bretter leicht zusammen und vernageln diese mit den Dachsparren. Achten Sie auf gleichbleibende Parallelität der Bretter!

Die Dachbretter müssen vorne und hinten bündig mit den Dachsparren abschließen - bei Bedarf die Bretter kürzen.

3.10. Dacheindeckung

Beginnen Sie mit der Verlegung der Dachpappe laut Abbildung an der unteren Seite des Daches (40 mm Überstand).

Montage der Dachrandbretter und Dachrandblenden.

3.11. Montage Boden

Legen Sie die Fußbodenbretter auf den Bodenrahmen und befestigen sie diese mit dem Bodenrahmen.



Achten Sie auf einen Abstand von 5 mm zu den Wänden, damit die Bretter bei Temperaturschwankungen arbeiten können!

Kürzen Sie die Fußbodenleisten auf Naturmaß und befestigen Sie diese an den Blockbohlen - nicht mit den Bodenbrettern!

3.12. Montage Inneneinrichtung

Montage Lüftungsschieber.

Montieren Sie die Stützleisten der Bänke laut Abbildungen.

Legen Sie zuerst die oberen Bänke ein und verschrauben Sie diese miteinander.

Legen Sie die untere Bank auf die Stützleisten.

Befestigen Sie die Banksichtblende und die Rückenlehnen laut Abbildungen.

3.13. Montage Innentür

Montieren Sie zuerst die Randleisten auf den Türrahmen (Vorraumseite). Stellen Sie die Innentür vom Vorraum aus in die Türöffnung und fixieren Sie diese durch die Montage der Türverblendung von der Sauna-Innenseite.

3.14. Montage Zubehör

Montage Licht und Lampenschutzgitter.

Montage Ofenschutzgitter.

Montage Lüftungsgitter außen.

Sauna de jardin

LAVA

345 x 234 x 260 cm

INSTRUCTIONS DE MONTAGE

Français

FR



Table des matières

1. Préparation du montage	3
1.1. Remarques importantes	3
1.2. Fondation	4
1.3. Ancrage du sauna extérieur	4
1.4. Outils requis	4
1.5. Entretien et nettoyage	6
1.6. Élimination	6
2. Plan de construction/fondation	7
3. Montage de la cabine	8
3.1. Montage du cadre de base	8
3.2. Montage des parois de la cabine	8
3.3. Montage de la porte	8
3.4. Montage de la fenêtre	8
3.5. Montage des parois	8
3.6. Montage du toit en appentis	9
3.7. Montage des tiges filetées	9
3.8. Montage des éléments de toit du sauna	9
3.9. Montage de l'extérieur du toit	9
3.10. Couverture du toit	9
3.11. Montage du plancher	10
3.12. Montage de l'équipement intérieur	10
3.13. Montage de la porte intérieure	10
3.14. Montage des accessoires	10
Illustration des dimensions (après la dernière langue)	11
Nomenclature (après la dernière langue)	12
Illustrations de montage (après la dernière langue)	16

1. Préparation du montage

Lisez attentivement ces instructions de montage et conservez-les. Vous avez ainsi accès à tout moment aux informations sur le produit.



Vous pouvez également trouver ces instructions de montage dans la zone de téléchargement de notre site Web : www.sentiotec.com/downloads.

1.1. Remarques importantes

- Renseignez-vous auprès de l'autorité locale chargée de la construction (bureau municipal, magistrat) sur les règles de construction et les normes relatives aux charges.
- Pour la durabilité et la sécurité de votre sauna extérieur, il est important que la fondation en béton soit solide. Nous vous recommandons de faire construire les fondations par un spécialiste.
- La responsabilité de l'ancrage du sauna extérieur incombe au client. Aucune garantie n'est accordée en cas de dommage.
- Le sauna extérieur est livré par camion (éventuellement par semi-remorque). Il faut donc veiller à ce que l'accès au site de déchargement soit possible.
- Avant de commencer les travaux, vérifiez au moyen de la nomenclature si toutes les pièces ont bien été livrées. S'il devait s'avérer que des pièces manquent, informez votre revendeur dans les 14 jours suivant la réception de la cabine.
- Conservez le bon de livraison, la facture et les instructions de montage en lieu sûr pour toute question éventuelle.
- Une deuxième personne doit être disponible pour vous aider.
- Tous les raccords vissés doivent être préalésés.



Attention !

Seul un électricien spécialisé ou une personne ayant une qualification similaire est habilité à procéder au raccordement électrique.

- Le feutre de toiture inclus dans la livraison sert de toiture initiale. Nous recommandons de recouvrir en outre la toiture de bardeaux de bitume, de tôle ou d'un film approprié.
- Malgré un stockage correct, le bois est un produit naturel qui peut gonfler, se contracter ou se déformer. C'est pourquoi il peut arriver que vous ayez à appliquer de la force lors du montage.

- Le bois du sauna extérieur n'est pas traité. Pour augmenter sa durée de vie, nous recommandons de peindre l'extérieur avec une peinture de protection du bois adaptée.
- Les pièces en bois utilisées à l'intérieur du sauna ne doivent pas être traitées avec de la peinture.

1.2. Fondation

Les fondations suivantes ont fait leurs preuves dans la pratique :

- Plaque de fondation (dalle)
- Semelles filantes

Dans les deux variantes, une fondation absolument horizontale et porteuse doit être garantie. Ce n'est que de cette manière qu'un montage parfait du sauna extérieur peut être garanti avec un ajustement exact.

Nous recommandons d'utiliser du ruban goudronné (barrière contre l'humidité) entre le bois situé à la base et le béton pour empêcher l'humidité de pénétrer dans le bois.

1.3. Ancrage du sauna extérieur

Il est très important que le sauna extérieur soit solidement ancré à la dalle ou aux semelles filantes. Par vent fort, de grandes forces peuvent agir sur la maisonnette de jardin. Afin d'éviter d'endommager votre propriété ou les biens de tiers, un ancrage professionnel est absolument nécessaire.

Nous attirons votre attention sur le fait que l'ancrage de la maisonnette de jardin est à la charge du client et que nous déclinons toute responsabilité pour les dommages qui pourraient survenir.

1.4. Outils requis

- Marteau, cales et maillet en caoutchouc
- Visseuse électrique avec bits pour vis en croix et Torx
- Ruban de mesure
- Foret de 4 mm, 5 mm, 6 mm, 20 - 30 mm de diamètre (pour le câble électrique du poêle de sauna)
- Niveau à bulle
- Clé à fourche de 17mm
- Couteau universel
- Échelle
- Scie



Ce symbole désigne les conseils et indications utiles.



Préalésage



Sciage à la bonne longueur



Clouage



Réalisation du câblage



Contrôle de l'angle droit :

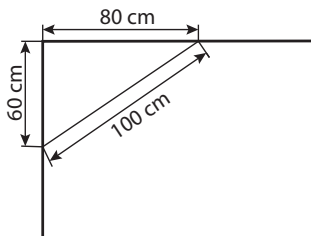

Manipulez le verre avec soin : Faire particulièrement attention avec les bords de la vitre ; en cas de choc, le verre trempé peut se briser en petits morceaux. Placez un rembourrage de protection (par ex., un emballage en carton) sous le bord de la vitre.

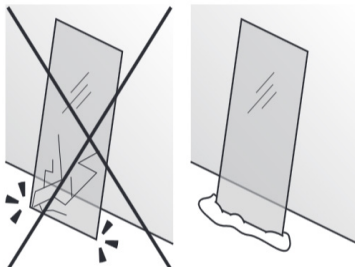

1.5. Entretien et nettoyage

- L'intérieur du sauna doit être nettoyé à l'aide d'un chiffon humide. N'utilisez que de l'eau chaude, pas de détergent.
- Si le sauna n'est pas utilisé pendant une période prolongée, nous recommandons de chauffer la cabine une fois par mois.



Les poches de résine ne constituent pas un motif de réclamation, en raison de leur présence régulière dans le bois d'épicéa et de l'impossibilité de déterminer leur profondeur lors de la sélection du bois.

Si elles se trouvent juste sous la surface, elles éclatent et s'écoulent quand elle sont exposées à la chaleur.

Retirez la résine écoulée à l'aide d'un chiffon imbibé d'acétone. Si vous constatez uniquement des gouttes de résine, attendez qu'elles aient durci, puis grattez-les avec précaution à l'aide d'un couteau.

1.6. Élimination



- Éliminez les matériaux d'emballage conformément aux directives en vigueur relatives à l'élimination.



2. Plan de construction/fondation

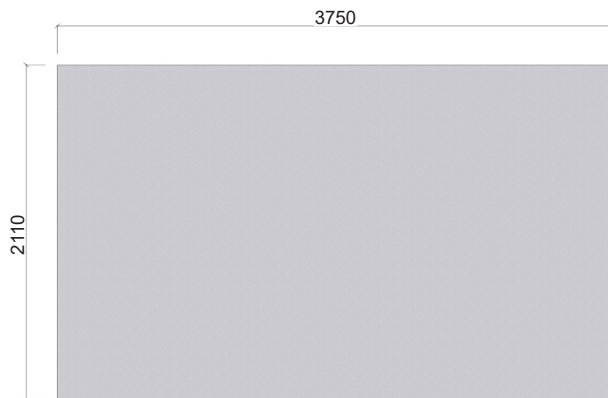
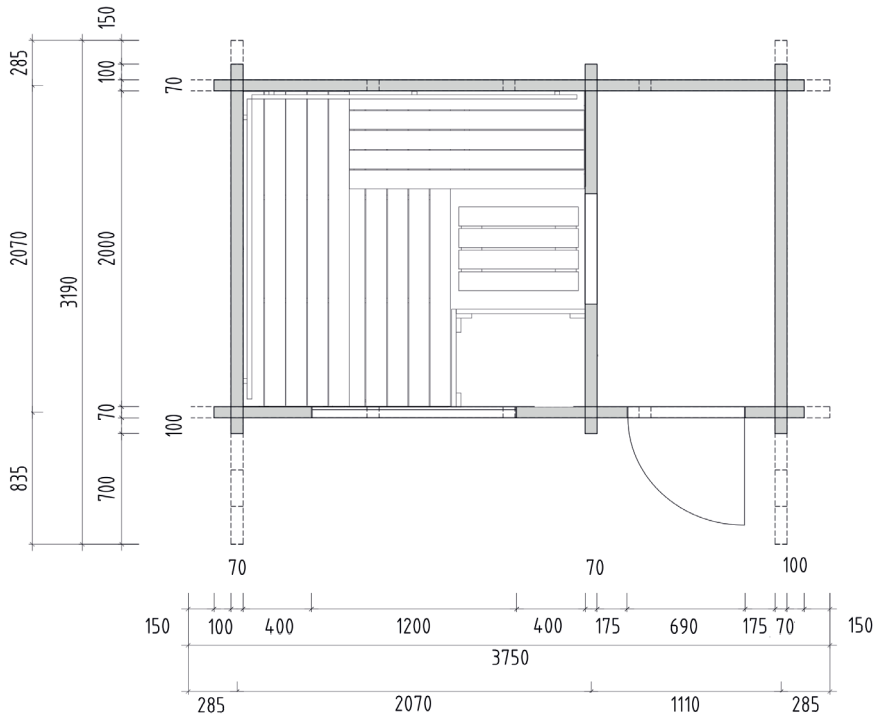

3. Montage de la cabine



ATTENTION !

Référez-vous aux plans de la page Page 7 et aux illustrations à partir de la page 11.

3.1. Montage du cadre de base

Placez le cadre de base imprégné sur la fondation comme indiqué sur le plan de construction et les illustrations de la fondation (voir Page 7).



Veillez à ce que le cadre de base soit monté à angle droit.
Faites attention à l'alimentation électrique !

3.2. Montage des parois de la cabine



Les planches de paroi sont toujours assemblées avec la languette vers le haut.

Ne frappez JAMAIS directement la languette avec le marteau !

Commencez par la pose des demi-planches des parois avant et arrière sur le cadre de base, puis placez les planches latérales.

Reliez les madriers situés aux coins à la fondation en béton (voir 1.3 à la page 4).

Procédez rangée par rangée jusqu'à la rangée 7 incluse. Veillez à la position du registre d'aération dans la rangée 2 et des madriers avec des trous pour l'installation électrique.

3.3. Montage de la porte

Le cadre de la porte se glisse dans l'ouverture par le haut (ouverture de la porte vers l'extérieur).

Montez les ferrures de porte.

3.4. Montage de la fenêtre

Montez le reste des madriers - jusqu'à la rangée 12 incluse.

Montez d'abord les habillages sur la fenêtre. Insérez la fenêtre par le haut dans l'ouverture.

3.5. Montage des parois

Montez le reste des madriers- jusqu'à la rangée 18 incluse.

Veillez au bon positionnement des madriers possédant des trous pour le câblage.

Vissez la garniture de porte et de fenêtre intérieure à angle droit.

3.6. Montage du toit en appentis

Mettez en place les éléments du toit en appentis à droite et à gauche. Retirez les madriers supérieurs inclinés pour insérer les madriers à l'avant.

3.7. Montage des tiges filetées

Raccordez les tiges filetées les unes aux autres comme indiqué sur la figure et insérez-les

par le haut dans les trous des madriers prévus à cet effet.

Vissez la bride sur la partie supérieure et fixez les rondelles de calage et les écrous sur la partie inférieure.

Procédez ensuite au montage de l'élément central du toit en appentis et de la tige filetée correspondante.

Préparez les trous pour l'équipement technique (poêle de sauna, commande, etc.).

3.8. Montage des éléments de toit du sauna

Montage des baguettes d'appui de toit

Mettez en place les éléments de toit.



Procédez à l'installation électrique – insérez les câbles !

Si les éléments de toit sont vissés par le haut, il n'est ensuite plus possible d'accéder à l'espace sous le toit. Il peut alors être nécessaire de découper une ouverture dans le pignon du toit pour l'inspection de l'équipement technique.

FR

3.9. Montage de l'extérieur du toit

Placez les chevrons dans les évidements conformément à l'illustration et vissez-les aux madriers.

Fixez les planches à rainure et languette aux chevrons en commençant par la face arrière. Frappez légèrement les planches pour les unir et clouez-les aux chevrons. Veillez à ce que les planches soient bien parallèles !

Les planches du toit doivent être alignées avec les chevrons à l'avant et à l'arrière. Raccourcissez les planches si nécessaire.

3.10. Couverture du toit

Commencez par la pose du feutre de toiture conformément à l'illustration sur la face inférieure du toit (dépassement de 40 mm).

Montage des planches et des caches de la bordure de toit.

3.11. Montage du plancher

Posez les planches de plancher sur le cadre de plancher et fixez-les avec ce dernier.



Veillez à laisser un espace de 5 mm aux parois pour que les planches puissent travailler en cas de variations de température !

Coupez les plinthes à la bonne longueur et fixez-les aux madriers – pas aux planches de plancher !

3.12. Montage de l'équipement intérieur

Montage du registre d'aération.

Montez les barres de support des bancs conformément aux illustrations.

Placez d'abord les bancs supérieurs et vissez-les entre eux.

Placez le banc inférieur sur les barres de support.

Fixez l'écran de banc et les dossiers conformément aux illustrations.

3.13. Montage de la porte intérieure

Montez d'abord les habillages sur le cadre de la porte (côté vestibule).

Placez la porte intérieure du vestibule dans l'ouverture de la porte et fixez celle-ci en montant la garniture de la porte à l'intérieur du sauna.

3.14. Montage des accessoires

Montage de l'éclairage et de la grille de protection de la lampe.

Montage de la grille de protection du poêle.

Montage de la grille d'aération extérieure.

Sauna da giardino

LAVA

345 x 234 x 260 cm

ISTRUZIONI DI MONTAGGIO

Italiano



IT

Indice

1. Preparazione per il montaggio	3
1.1. Indicazioni importanti	3
1.2. Fondamenta	4
1.3. Ancoraggio della sauna all'aperto	4
1.4. Attrezzi necessari	4
1.5. Manutenzione e pulizia	6
1.6. Smaltimento	6
2. Pianta/fondamenta	7
3. Montaggio cabina	8
3.1. Montaggio telaio di base	8
3.2. Montaggio delle pareti della cabina	8
3.3. Montaggio della porta	8
3.4. Finestre di montaggio	8
3.5. Montaggio delle pareti	8
3.6. Montaggio del tetto a falda unica	9
3.7. Montaggio delle aste filettate	9
3.8. Montaggio degli elementi del tetto della sauna	9
3.9. Montaggio del tetto esterno	9
3.10. Copertura del tetto	9
3.11. Montaggio del pavimento	10
3.12. Montaggio dell'allestimento interno	10
3.13. Montaggio della porta interna	10
3.14. Montaggio accessori	10
Figura Misure (dopo l'ultima lingua)	11
Elenco dei pezzi (dopo l'ultima lingua)	12
Figure di montaggio (dopo l'ultima lingua)	16

1. Preparazione per il montaggio

Leggere con attenzione le presenti istruzioni di montaggio e conservarle. In questo modo è possibile controllare in qualsiasi momento le informazioni relative al prodotto.



Le presenti istruzioni di montaggio sono disponibili anche nella sezione download del nostro sito web all'indirizzo: www.sentiotec.com/downloads.

1.1. Indicazioni importanti

- Informatevi presso l'autorità edilizia competente locale (ufficio comunale o autorità comunali) per i regolamenti edilizi e gli standard di carico.
- Solide fondamenta in cemento sono importanti per la durata e la sicurezza della vostra sauna all'aperto. Vi consigliamo di far eseguire le fondamenta da un professionista.
- L'ancoraggio della sauna esterna è responsabilità del cliente. Nessuna garanzia in caso di danni.
- La sauna all'aperto è consegnata da un camion (eventualmente anche da un autoarticolato). Di conseguenza è necessario assicurarsi che sia possibile l'accesso al luogo di scarico.
- Prima di iniziare i lavori, controllare in base all'elenco dei pezzi se tutti i singoli componenti sono stati effettivamente forniti. Se eccezionalmente dovessero mancare dei singoli componenti, contattare il proprio fornitore entro 14 giorni dal ricevimento della cabina.
- Conservate la bolla di consegna, la fattura e le istruzioni di montaggio in un luogo sicuro per eventuali domande.
- Per il montaggio è richiesto l'aiuto di una seconda persona.
- Tutte le connessioni a vite devono essere preforate.



Attenzione!

Il collegamento elettrico deve essere eseguito da elettricisti specializzati o da persone con una qualifica simile.

- Il cartone catramato in dotazione serve come copertura iniziale. Si consiglia di coprire ulteriormente il tetto con tegole bituminose, lamiera o una lamina adatta.
- Il legno è un prodotto naturale che può gonfiarsi, ritirarsi o deformarsi anche se immagazzinato correttamente. In fase di montaggio potrebbe quindi essere necessario applicare una certa forza.

- Il legno della sauna esterna non è trattato. Per aumentare la durata di vita, si consiglia di dipingere l'esterno con una vernice protettiva per legno adatta.
- I componenti in legno da utilizzare all'interno non devono essere trattati con vernice.

1.2. Fondamenta

I seguenti elementi per le fondamenta hanno dimostrato la loro efficacia nella pratica:

- piastra di fondazione (piastra di base)
- striscia di fondazione

Con entrambe le varianti, devono essere garantite fondamenta perfettamente orizzontali e portanti. Solo in questo modo è possibile garantire una perfetta installazione della sauna esterna con un adattamento esatto.

Si consiglia di usare del nastro di catrame (foglio impermeabilizzante) tra il legno del basamento e il cemento per evitare che l'umidità penetri nel legno.

1.3. Ancoraggio della sauna all'aperto

È molto importante che la sauna all'aperto sia saldamente ancorata alla piastra di fondo o alla striscia di fondazione. In caso di vento forte, grandi forze possono agire sulla casetta da giardino. Per evitare danni alla vostra proprietà o a quella di altri, un ancoraggio professionale è assolutamente necessario.

Vorremmo sottolineare che l'ancoraggio della casetta da giardino è di responsabilità del cliente e non ci assumiamo nessuna responsabilità per eventuali danni.

1.4. Attrezzi necessari

- Martello, pezzo di legno e martello in gomma
- Avvitatore elettrico con punte per viti con testa a croce e viti Torx
- Metro a nastro avvolgibile
- Punta per trapano da 4 mm, 5 mm, 6 mm, 20-30 mm (per cavo elettrico della stufa per sauna)
- Livella a bolla
- Chiave fissa da 17 mm
- Cutter
- Scala
- Sega



Questo simbolo indica consigli e indicazioni utili



Preforatura



Taglio alla lunghezza effettiva



Inchiodamento



Cablaggio



Verifica dell'ortogonalità:

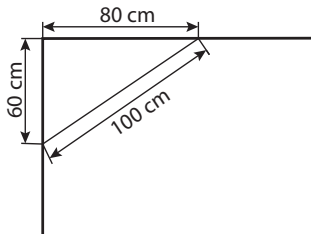

Maneggiare il vetro con cura: particolare attenzione deve essere prestata ai bordi del vetro - il vetro temprato può frantumarsi in piccoli pezzi in caso di impatto. Inserire un cuscino di protezione (ad es: scatola di cartone) sotto il bordo del vetro.

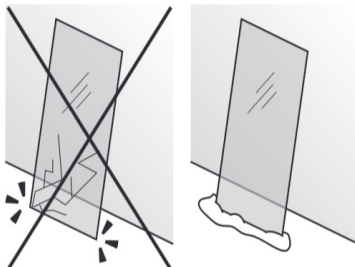

1.5. Manutenzione e pulizia

- La sauna all'interno deve essere pulita con un panno umido. Utilizzare solo acqua calda senza detersivi.
- Se la sauna non viene utilizzata per un tempo prolungato, si consiglia di riscaldare la cabina una volta al mese.



Le tasche di resina non sono motivo di reclamo perché nel legno di abete rosso sono sempre presenti e durante la selezione non è possibile rilevare a quale profondità si trovino.

Quando sono appena al di sotto della superficie, con lo sviluppo del calore si rompono e possono "essudare".

Rimuovere la resina fuoriuscita con un panno imbevuto di acetone.

Se sono presenti solo gocce di resina, lasciarle indurire e poi raschiarle con cautela usando un coltello.

1.6. Smaltimento



- Smaltire i materiali dell'imballaggio conformemente alle normative sullo smaltimento vigenti.



2. Pianta/fondamenta

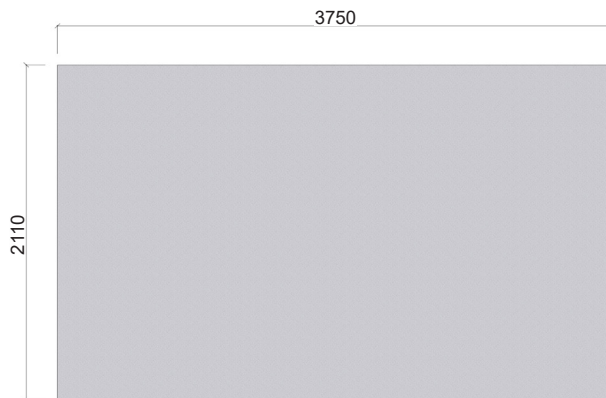
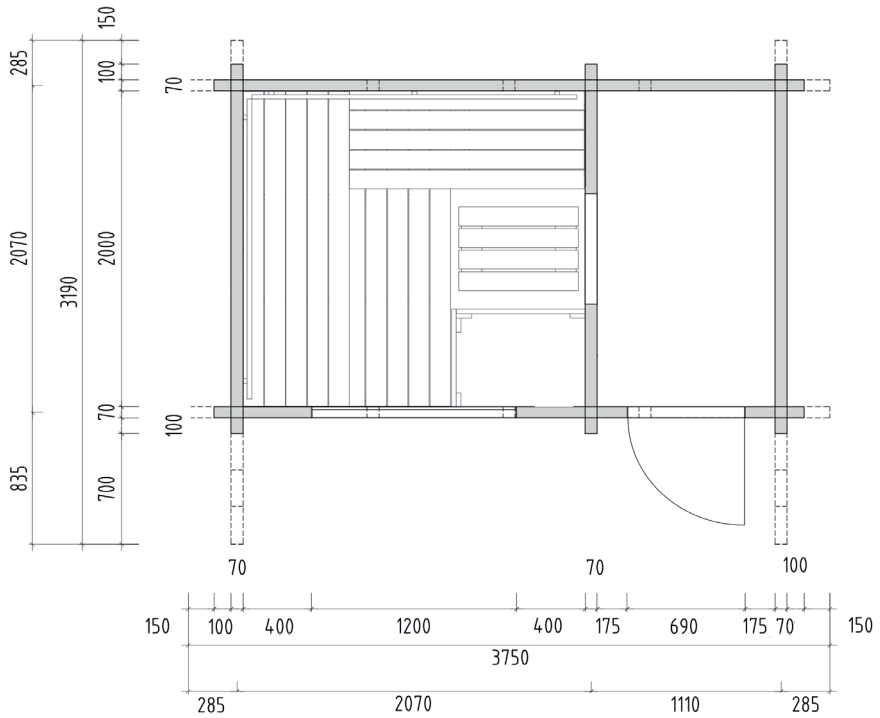

3. Montaggio cabina



ATTENZIONE!

Osservare la pianta a Pagina 7 e le figure da Pagina 11.

3.1. Montaggio telaio di base

Posizionare il telaio di base impregnato sulle fondamenta come mostrato nella pianta e nelle immagini delle fondamenta (vedi Pagina 7).



Verificare che il telaio di base sia montato ad angolo retto.

Osservare l'alimentazione elettrica!

3.2. Montaggio delle pareti della cabina



Le travi per parete sono sempre montate insieme con la molla rivolta verso l'alto.

Non colpire MAI la molla direttamente con il martello!

Iniziare a posare le mezze travi della parete anteriore e della parte posteriore sul telaio di base e poi posizionare le travi laterali.

Collegare le travi per Blockhaus alle fondamenta in cemento in corrispondenza degli angoli (vedi 1.3 a pagina 4).

Continuare fila per fila - fino alla fila 7 inclusa. Osservare la posizione del cursore di ventilazione nella fila 2 e le travi per Blockhaus con i fori per l'installazione elettrica.

3.3. Montaggio della porta

Il telaio della porta viene inserito dall'alto nell'apertura (apertura della porta verso l'esterno).

Montare la cerniera della porta.

3.4. Finestre di montaggio

Montare le rimanenti travi per Blockhaus - fino alla fila 12 compresa.

Per prima cosa, montare i listelli di bordo sulla finestra. Far scorrere la finestra nell'apertura dall'alto.

3.5. Montaggio delle pareti

Montare le rimanenti travi per Blockhaus - fino alla fila 18 compresa.

Osservare il posizionamento delle travi per Blockhaus con i fori per il cablaggio.

Avvitare il rivestimento della porta e della finestra internamente ad angolo retto.

3.6. Montaggio del tetto a falda unica

Inserire gli elementi del tetto a falda unica a destra e a sinistra. Rimuovere le travi per Blockhaus superiori inclinate per inserire le tavole per Blockhaus nella parte anteriore.

3.7. Montaggio delle aste filettate

Collegare le aste filettate tra loro come da figura e inserirle dall'alto negli appositi fori delle travi per Blockhaus.

Avvitare la flangia sul lato superiore e fissare le rondelle e i dadi sul lato inferiore.

Poi montare l'elemento centrale del tetto a falda unica e l'asta filettata corrispondente.

Predisporre i fori per l'impianto tecnico (stufa per sauna, comando,...).

3.8. Montaggio degli elementi del tetto della sauna

Montaggio dei listelli di supporto del tetto.

Inserire gli elementi del tetto.



Eseguire l'installazione elettrica - inserire i cavi!

Se gli elementi del tetto vengono avvitati dall'alto, non sarà più possibile accedere all'intercapedine del tetto. Potrebbe quindi essere necessario tagliare un'apertura di ispezione nel frontone del tetto per l'impianto tecnico.

3.9. Montaggio del tetto esterno

Posizionare i falsi puntoni nelle cavità come da figura e avvitarli alle travi per Blockhaus.

Fissare le perline maschio-femmina ai falsi puntoni iniziando dal lato posteriore. Battere leggermente le perline fra loro e inchiodarle ai falsi puntoni. Assicurarsi che le perline siano costantemente parallele!

Le tavole del tetto devono essere a filo con i falsi puntoni sul lato anteriore e posteriore – se necessario, accorciare le tavole.

3.10. Copertura del tetto

Iniziare la posa del cartone catramato come da figura sul lato inferiore del tetto (40 mm di sporgenza).

Montaggio delle tavole del bordo tetto e delle cornici del bordo tetto.

3.11. Montaggio del pavimento

Posizionare le tavole del pavimento sul telaio del pavimento e fissarle a quest'ultimo.



Garantire una distanza di 5 mm dalle pareti in modo che le tavole possano dilatarsi in caso di sbalzi di temperatura!

Accorciare i battiscopa alla lunghezza effettiva e fissarli alle travi per Blockhaus ma non alle tavole del pavimento!

3.12. Montaggio dell'allestimento interno

Montaggio del pannello scorrevole di aerazione.

Montare i listelli di supporto delle panche come da figure.

Innanzitutto inserire le panche superiori e avvitarle insieme.

Posizionare la panca inferiore sui listelli di supporto.

Fissare il pannello di rivestimento della panca e gli schienali come da figure.

3.13. Montaggio della porta interna

Per prima cosa montare le tavole del bordo sul telaio della porta (lato anticamera).

Posizionare la porta interna dell'anticamera nell'apertura della porta e fissarla montando il rivestimento della porta dal lato interno della sauna.









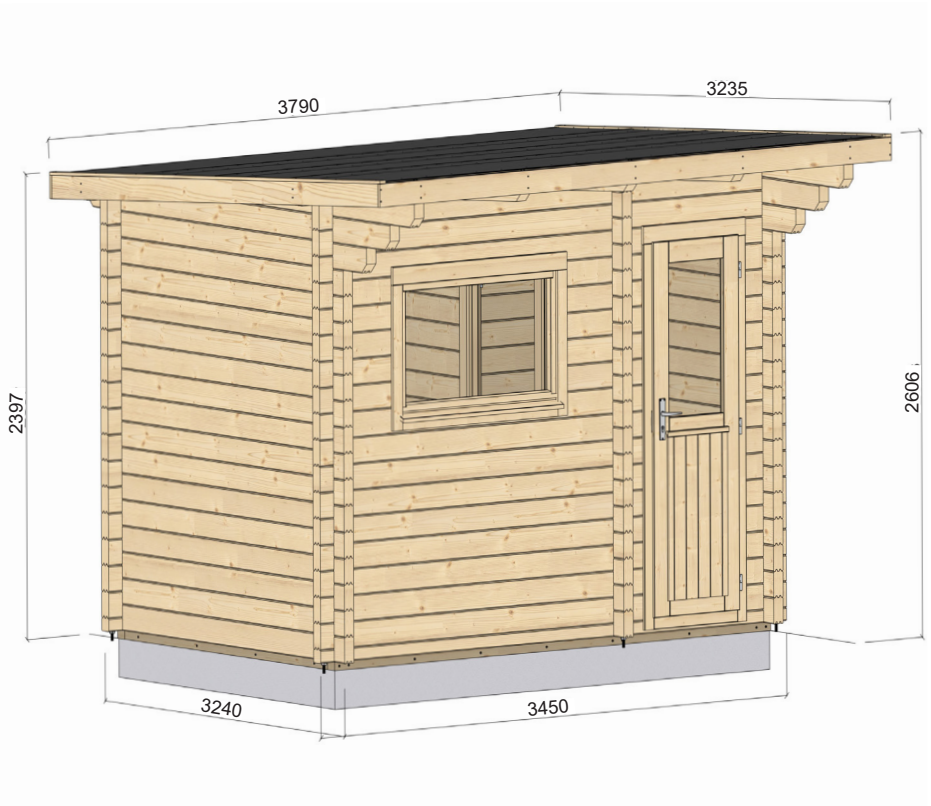

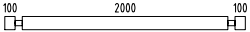
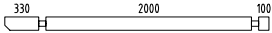
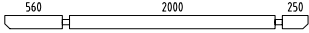
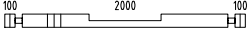
3.14. Montaggio accessori

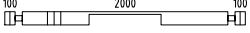
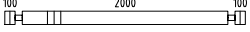
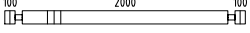
Montaggio della griglia di protezione della luce e della lampada.

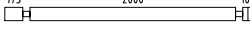
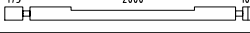

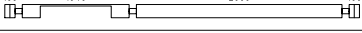
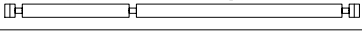
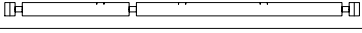
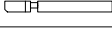

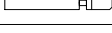
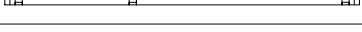
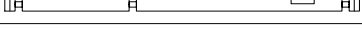















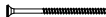

Montaggio della griglia di protezione della stufa.

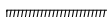



Montaggio della griglia di ventilazione all'esterno.





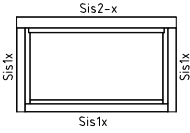
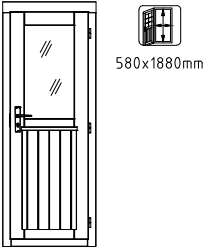
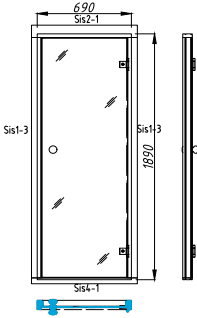





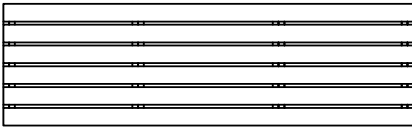
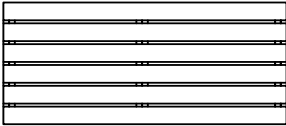
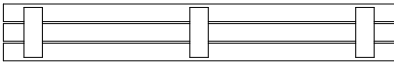
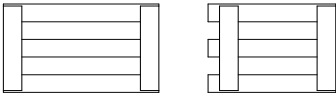

Pos	SPECIFICATION-STÜCKLISTE-NOMENCLATURE-ELEMENTI-ESPECIFICACIÓN	Pcs	Profile (mm)	Length (mm)
001		30	70x135	2340
002		2	70x135	2570
003		2	70x135	2950
006		1	70x135	2340
007		13	70x135	820
008		13	70x135	820
009		1	70x135	2340
010		1	70x135	2340
011		1	70x135	2340
014		1	70x68	3450
015		14	70x135	345
016		8	70x135	2415
017		1	70x135	2415
018		5	70x135	645
019		5	70x135	570
020		1	70x135	3450
021		15	70x135	3450
022		1	70x135	3450
023		2	70x110	1045
024		2	70x110	725
025		2	70x110	725
026		2	70x110	1045
027		1	70x68	3450
028		1	70x135	3450
029		1	70x135	3450

Pos	SPECIFICATION-STÜCKLISTE-NOMENCLATURE-ELEMENTI-ESPECIFICACIÓN	Pcs	Profile (mm)	Length (mm)
W1-1		1		
W2-1		1		
W3-1		1		
AR1	Foundation- Fundament- Fondation- Fondazione- Vigas de cimentación 	2	70x45	3230
AR2	Foundation- Fundament- Fondation- Fondazione- Vigas de cimentación 	10	70x45	1980
RoR1	Rafter- Sparre- Chevron- Trave- Cabrio 	3	70x140	3204
SP1	Support brace- Stützleiste- Baguette de support- Listello di supporto- Listón de soporte 	5	45x70	590
SP2	Support brace- Stützleiste- Baguette de support- Listello di supporto- Listón de soporte 	2	45x45	2000
SP3	Support brace- Stützleiste- Baguette de support- Listello di supporto- Listón de soporte 	2	45x45	1910
FB2-1	Floor board- Fussbodenbrett- Madrier du plancher - Tavola pavimento- Tabla de suelo 	23	89x19	1995
FB2-2	Floor board- Fussbodenbrett- Madrier du plancher - Tavola pavimento- Tabla de suelo 	23	89x19	1034
RB2-1	Roof board- Dachbrett- Madrier du toit- Tavola tetto- Tabla de tejado 	36	89x19	3750
FIB1-1	Floor beading- Fussbodenleiste- Baguette du plancher- Listello pavimento- Listón de suelo 	7	19x19	2050
EaE6-1	Eave edging- Dachrandbrett- Madrier en bordure du toit- Tavola bordo tetto- Tabla de valadizo 	2	19x120	3790
FaB7-1	Facia board- Giebelblende- Écran frontal- Schermo frontone- Tabla de facia 	2	19x120	3190
YPapp-1	Roof felt- Dachpappe- Carton bitume- Cartone catramato- Fieltro de tejado 	4		4000
Sis4-1	Side slat- Randleiste- Baguette en bordure- Listón de borde- Listello bordo 	1	19x45	796
Sis1-1	Side slat- Randleiste- Baguette en bordure- Listón de borde- Listello bordo 	4	19x70	713
Sis1-2	Side slat- Randleiste- Baguette en bordure- Listón de borde- Listello bordo 	2	19x70	1154
Sis1-3	Side slat- Randleiste- Baguette en bordure- Listón de borde- Listello bordo 	2	19x70	1850
Sis2-1	Side slat- Randleiste- Baguette en bordure- Listón de borde- Listello bordo 	1	19x95	796
Sis2-2	Side slat- Randleiste- Baguette en bordure- Listón de borde- Listello bordo 	2	19x95	1294
WB1-1	Wind brace- Windbrett- Madrier contre le vent- Tavola vento- Tabla contra el viento 	2	16x45	3230

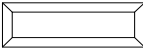
Pos	SPECIFICATION-STÜCKLISTE-NOMENCLATURE-ELEMENTI-ESPECIFICACIÓN	Pcs	Profile (mm)	Length (mm)
Fim	-Fixing kit - Befestigungsset - Moyens de fixation - Materiale di fissaggio - Kit de fijación	1	USE	
QULSI 30x35	Cylinder - Zylinderschloss - Serrure a mortaiser - Serratura a cilindro - Bombin - 30.35 	1	U70-76P	
QLIUHb	Door fittings- Türbeschlag- Ferrure- Ferramenta porta- Manilla puerta- QLIUHb 	1	U70-76P	
QULKAK	Door fittings- Türbeschlag- Ferrure- Ferramenta porta- Manilla puerta- QULKAK 	1	U70-76P	
QUN	Door fittings- Türbeschlag- Ferrure- Ferramenta porta- Manilla puerta- QUN 	1	U70-96P	
QNA1 4x40Me	Nail - Nagel - Clou - Chiodo - Clavo - 1.4x40mm 	50	FIB1-1	
QNA2 2x50Zn	Nail - Nagel - Clou - Chiodo - Clavo - 2.5x50mm 	200	FB2-1	
QNA3 x70Zn	Nail - Nagel - Clou - Chiodo - Clavo - 3x70mm 	200	RB2-1	
QNA2 x16Zn	Roofnail - Dachpappnagel - Clou pour carton bitumé - Chiodo di cartone castrato - Tachuela fieltro tejado - 2.0x16mm 	250		
QKRPP3 5x40Zn	Screw - Schraube - Vis - Vite - Tornillo - 3.5x40mm 	20	Slab-1 Slab-2 Slab-1-1	
QKRPP4 5x50Zn	Screw - Schraube - Vis - Vite - Tornillo - 4.5x50mm 	240	Diagonal Slab-1, Slab-2, Slab-1-1, Slab-1-2, Slab-1-3, Slab-1-4, Slab-1-5, Slab-1-6, Slab-1-7, Slab-1-8, Slab-1-9, Slab-1-10, Slab-1-11, Slab-1-12, Slab-1-13, Slab-1-14, Slab-1-15, Slab-1-16, Slab-1-17, Slab-1-18, Slab-1-19, Slab-1-20, Slab-1-21, Slab-1-22, Slab-1-23, Slab-1-24, Slab-1-25, Slab-1-26, Slab-1-27, Slab-1-28, Slab-1-29, Slab-1-30, Slab-1-31, Slab-1-32, Slab-1-33, Slab-1-34, Slab-1-35, Slab-1-36, Slab-1-37, Slab-1-38, Slab-1-39, Slab-1-40, Slab-1-41, Slab-1-42, Slab-1-43, Slab-1-44, Slab-1-45, Slab-1-46, Slab-1-47, Slab-1-48, Slab-1-49, Slab-1-50, Slab-1-51, Slab-1-52, Slab-1-53, Slab-1-54, Slab-1-55, Slab-1-56, Slab-1-57, Slab-1-58, Slab-1-59, Slab-1-60, Slab-1-61, Slab-1-62, Slab-1-63, Slab-1-64, Slab-1-65, Slab-1-66, Slab-1-67, Slab-1-68, Slab-1-69, Slab-1-70, Slab-1-71, Slab-1-72, Slab-1-73, Slab-1-74, Slab-1-75, Slab-1-76, Slab-1-77, Slab-1-78, Slab-1-79, Slab-1-80, Slab-1-81, Slab-1-82, Slab-1-83, Slab-1-84, Slab-1-85, Slab-1-86, Slab-1-87, Slab-1-88, Slab-1-89, Slab-1-90, Slab-1-91, Slab-1-92, Slab-1-93, Slab-1-94, Slab-1-95, Slab-1-96, Slab-1-97, Slab-1-98, Slab-1-99, Slab-1-100	
QKRPP4 5x70Zn	Screw - Schraube - Vis - Vite - Tornillo - 4.5x70mm 	60	014,027,004,005,012,013 Rel-1+Wall EL3	
QKRPP5 x100Zn	Screw - Schraube - Vis - Vite - Tornillo - 5x100mm 	70	SP1, SP2, SP3 EL4, EL5, wall+PRx	
QKRP P6x1 20ZnTX	Screw - Schraube - Vis - Vite - Tornillo - 6x120mm TX 	10	004,005 012,013	
QKRPP6 x150Zn	Screw - Schraube - Vis - Vite - Tornillo - 6x150mm 	20	ARx	
QKRPP 8x220 kZnTX	Screw - Schraube - Vis - Vite - Tornillo - 8x220mm 	6	RoR1	
KL1	Threaded rod - Gewindestangen - Barre fileté - Asta filettata - Varilla roscada M10 	6		2000
KL2	Threaded rod - Gewindestangen - Barre fileté - Asta filettata - Varilla roscada M10 	2		520
KL3	Threaded rod - Gewindestangen - Barre fileté - Asta filettata - Varilla roscada M10 	1		480
KL4	Threaded rod - Gewindestangen - Barre fileté - Asta filettata - Varilla roscada M10 	2		380
KL5	Threaded rod - Gewindestangen - Barre fileté - Asta filettata - Varilla roscada M10 	1		340
QMUk K10ZN	Nut - Schraubenmutter - Écrou - Dado - Tuerca - M10mm 	6		
QSE12 x35Zn	Washer - Dichtscheibe - Joint - Rondella - Arandela - 12x37mm 	6		
QMUJ 10ZN	Extension nut - Verlängerungsmutter - Écrou rallonge - Dado di prolunga - Tuerca de extensión - JM10 	6		
QMUP L10ZN	Top nut - Schweissmutter mit Flansch - Ecrou a souder - Dado a saldare - Tuerca soldable - M10 	6		

Pos	SPECIFICATION-STÜCKLISTE-NOMENCLATURE-ELEMENTI-ESPECIFICACIÓN	Pcs	Profile (mm)	Length (mm)
A70-69	<p>Window - Fenster - Fenetre - Finestra-Ventana 1190x685</p> 	1		
U70-76P	<p>Door - Tür - Porte - Porta-Puerta 680x1980</p> 	1		
U70-96P	<p>Door - Tür - Porte - Porta-Puerta 690x1890</p> 	1		
Sla6-1	Slat- Leiste- Baguette- Listello- Listón 	1	19x19	690
Sla6-2	Slat- Leiste- Baguette- Listello- Listón 	2	19x19	1980
Sla12-1	Slat- Leiste- Baguette- Listello- Listón 	1	19x70	690

Pos	SPECIFICATION-STÜCKLISTE-NOMENCLATURE-ELEMENTI-ESPECIFICACIÓN	Pcs	Profile (mm)	Length (mm)
EL1		2	620x118	1990
EL2		1	620x118	1375
EL3		2	290x56	1900
EL4		1		
EL5		1		
EL6		1		
EL7		1		
Rel-1	Roof element - Dachelement - Panneau de toit - Elemento di tetto - Elemento tejado 	2	990x72	1990
QQ-Harvia	Light screen 	1		
	Interior light 			
	Ventilation shutter 			
MMKSIHF1_5x3-1	MMKSIHF1_5x3 	1		3000
MMKSIHF2_5x5-1	MMKSIHF2_5x5 	1		3000
	Ventilation shutte 	1		

3.1.

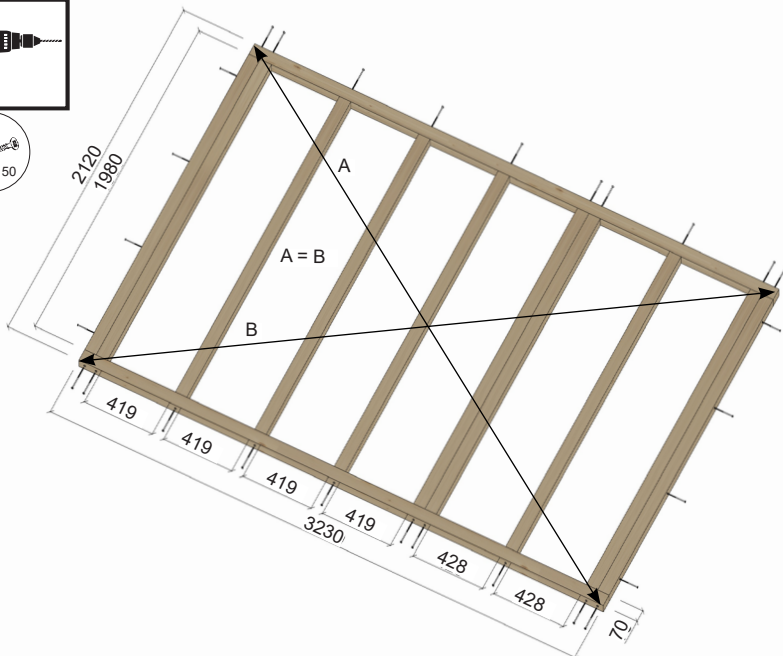
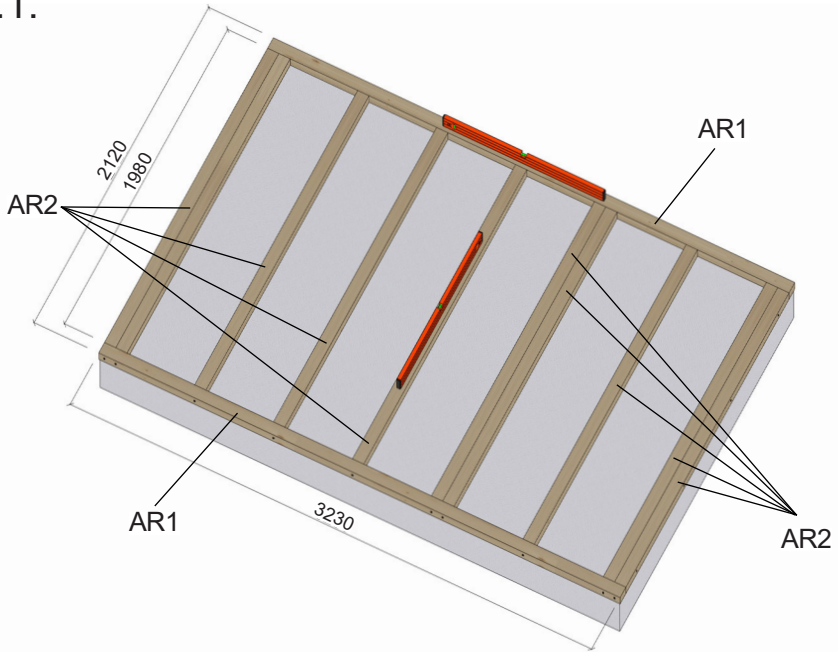

3.2.

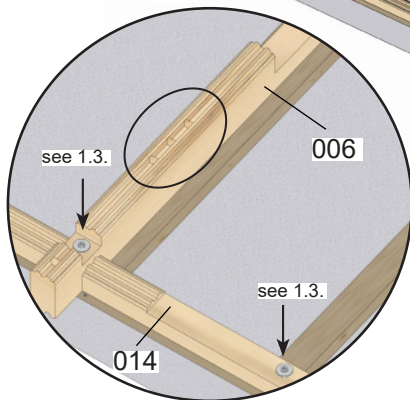
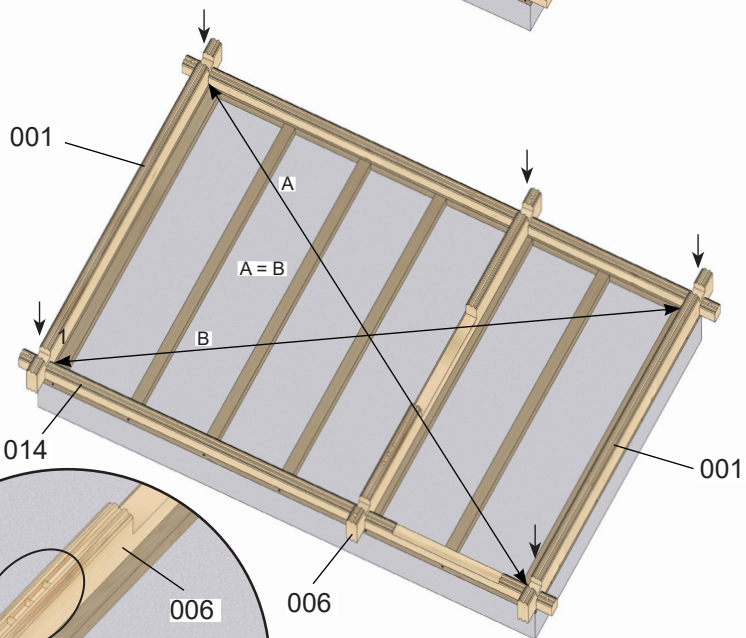
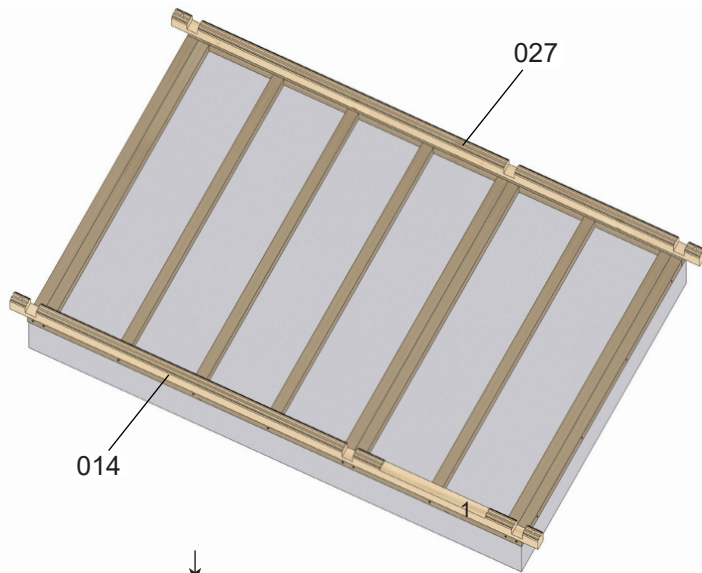

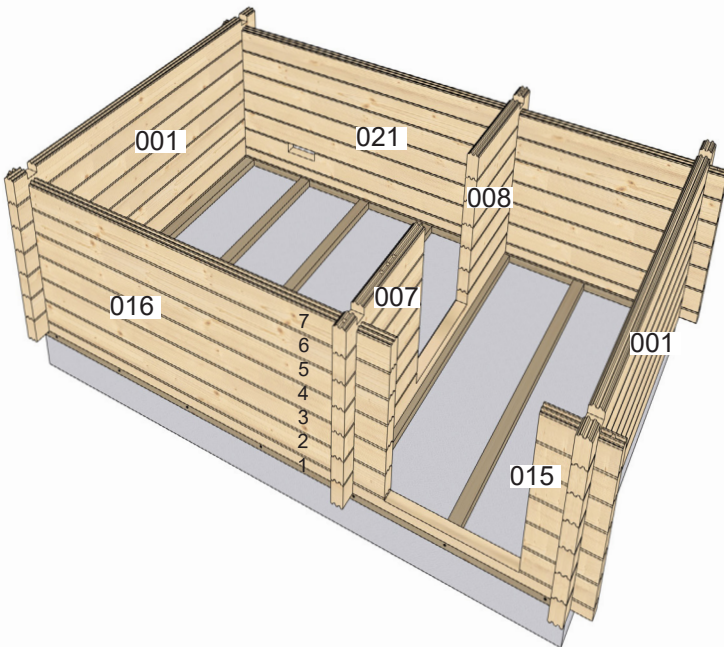
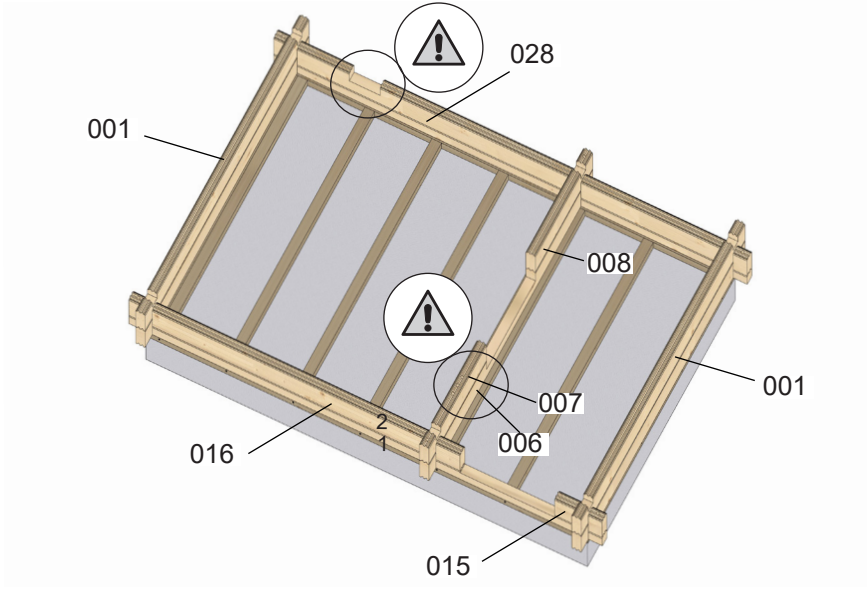

3.3.

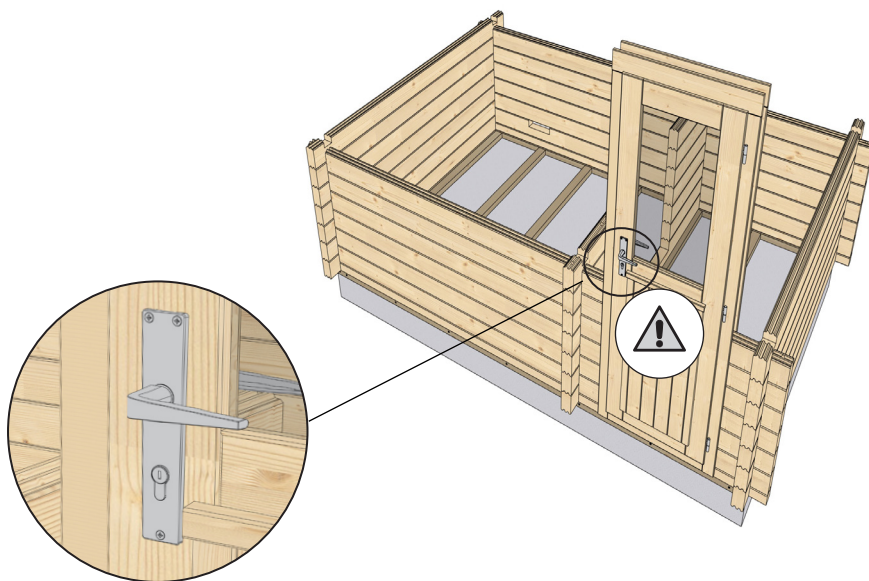
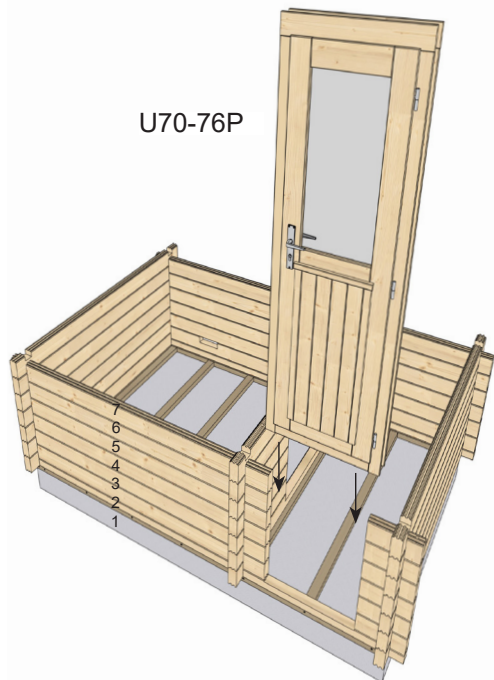

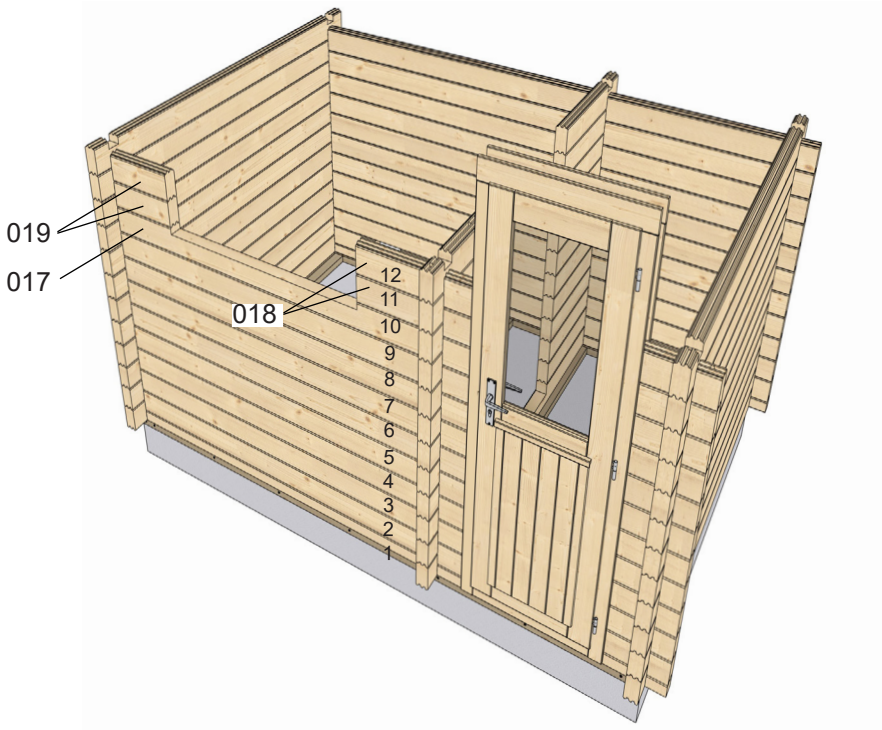

3.4.

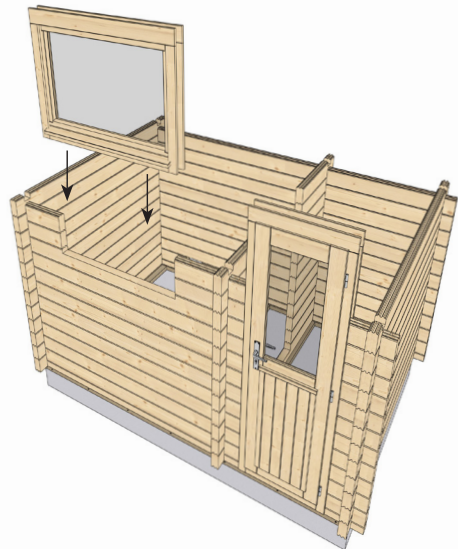
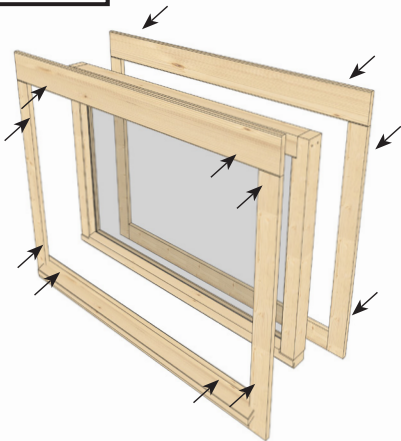

3.5

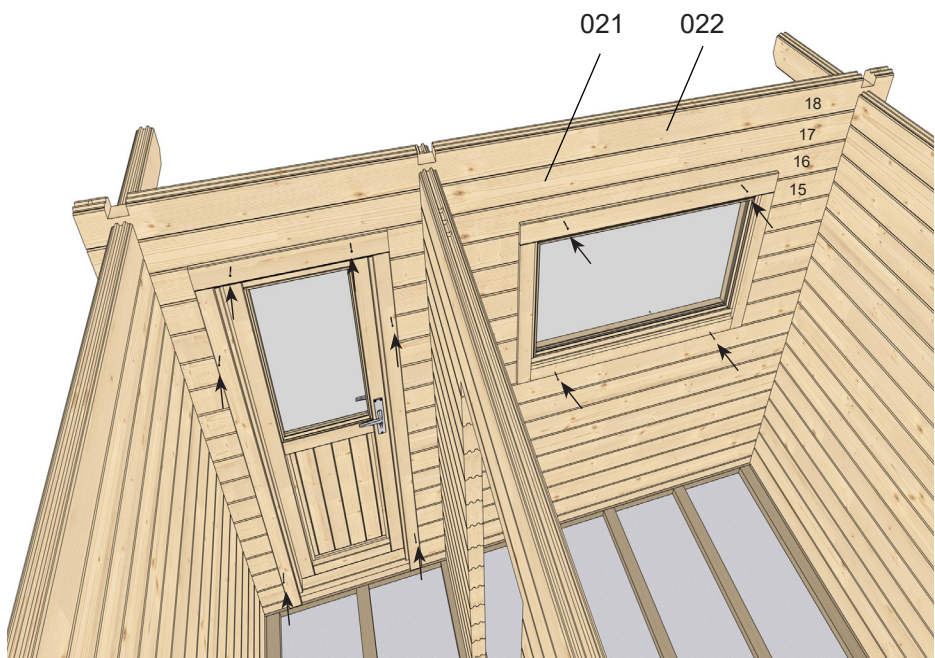
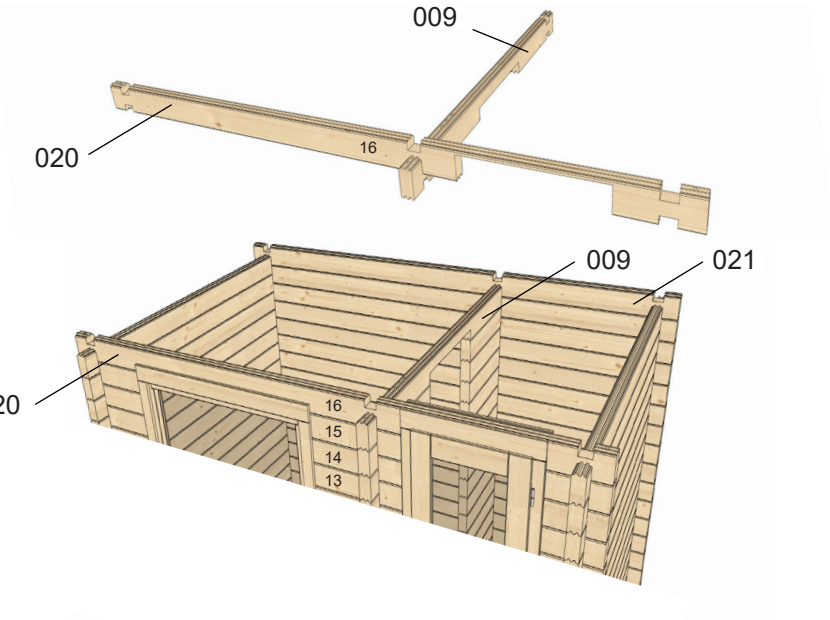

3.6.

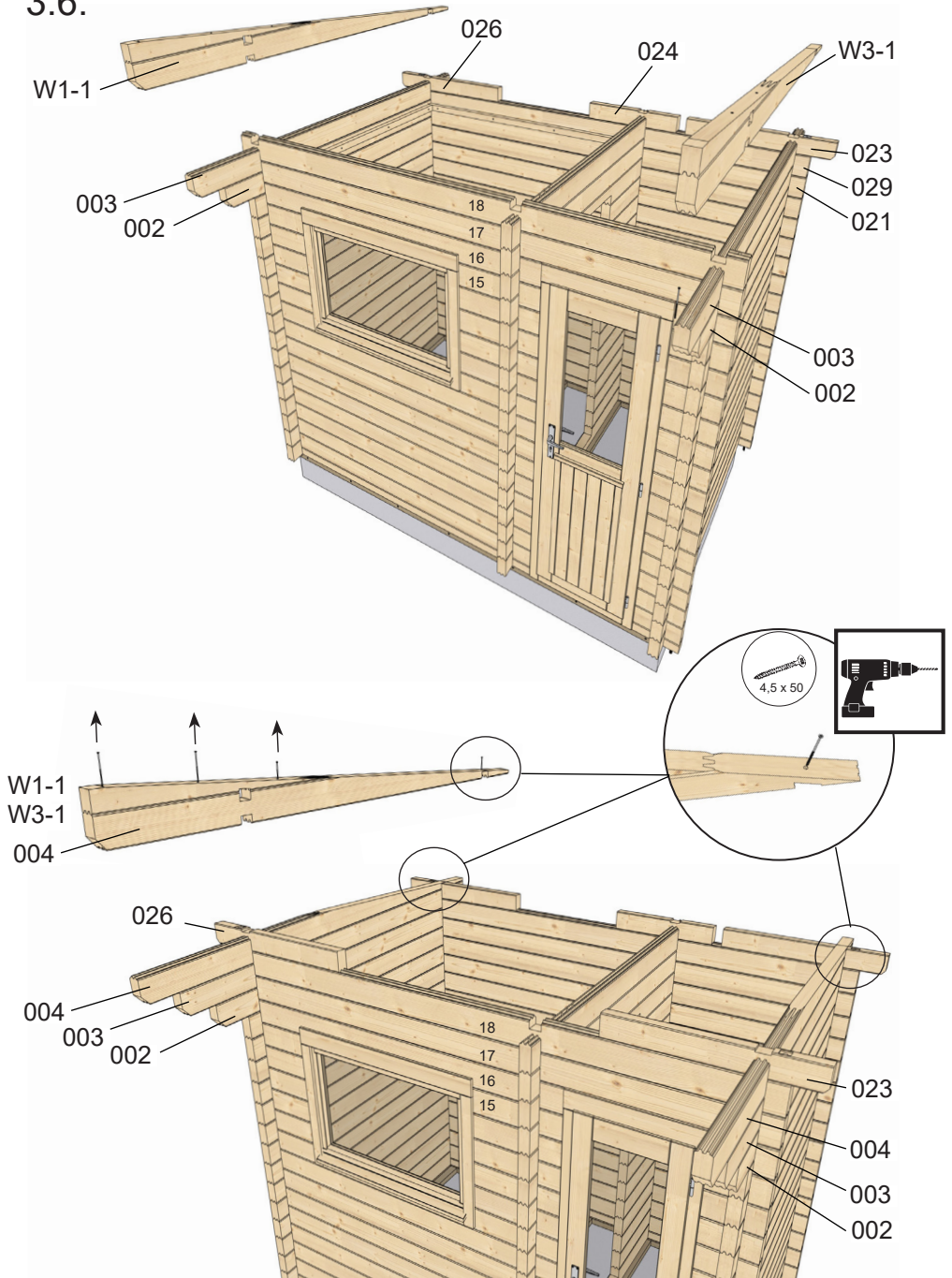

3.7.

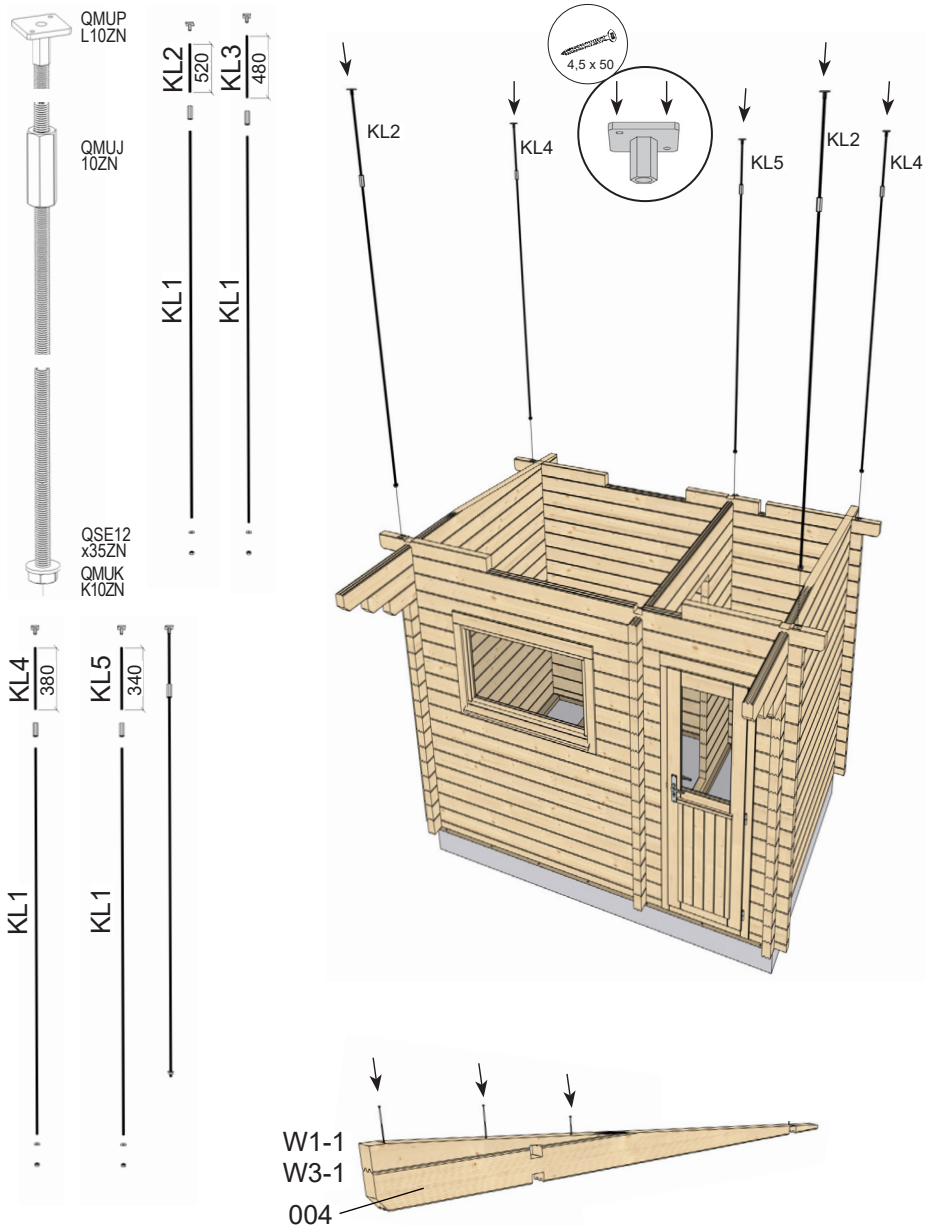

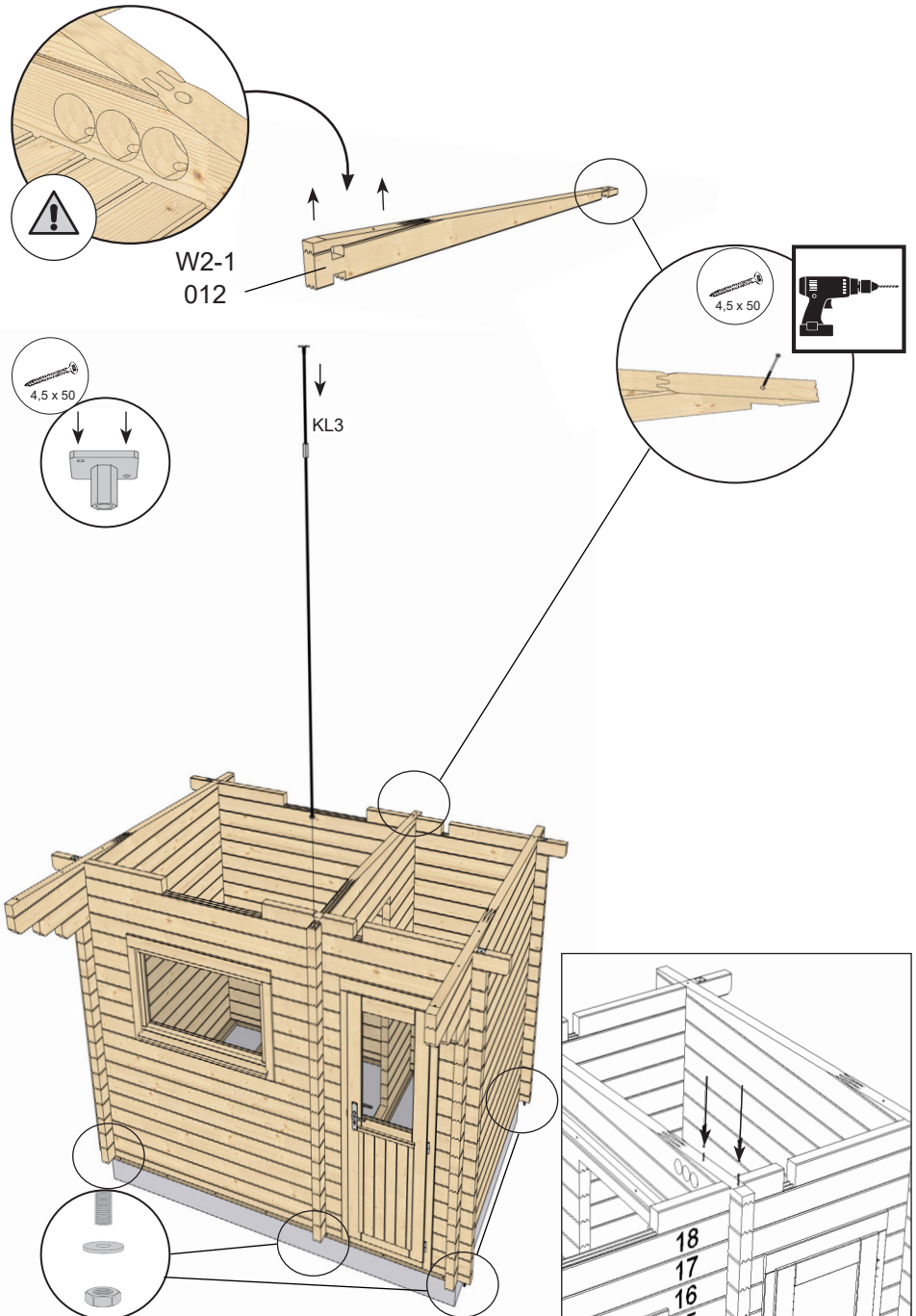

3.8.

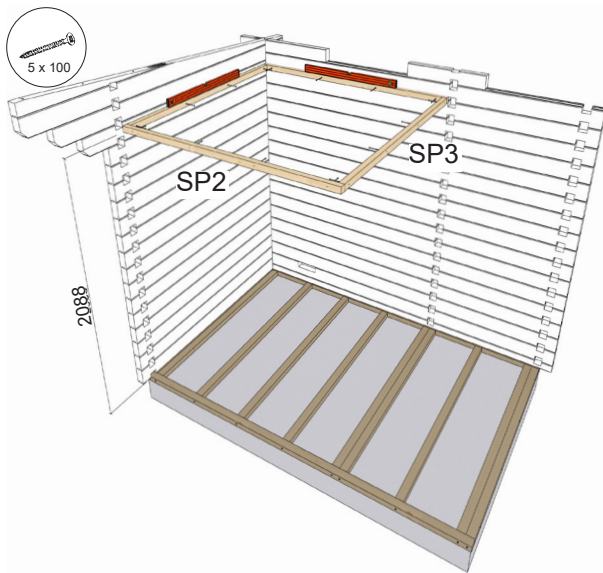
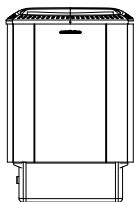
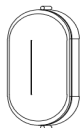
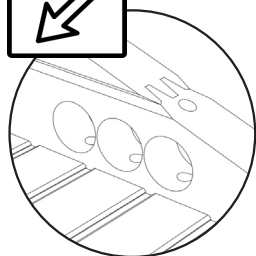

see 3.8.

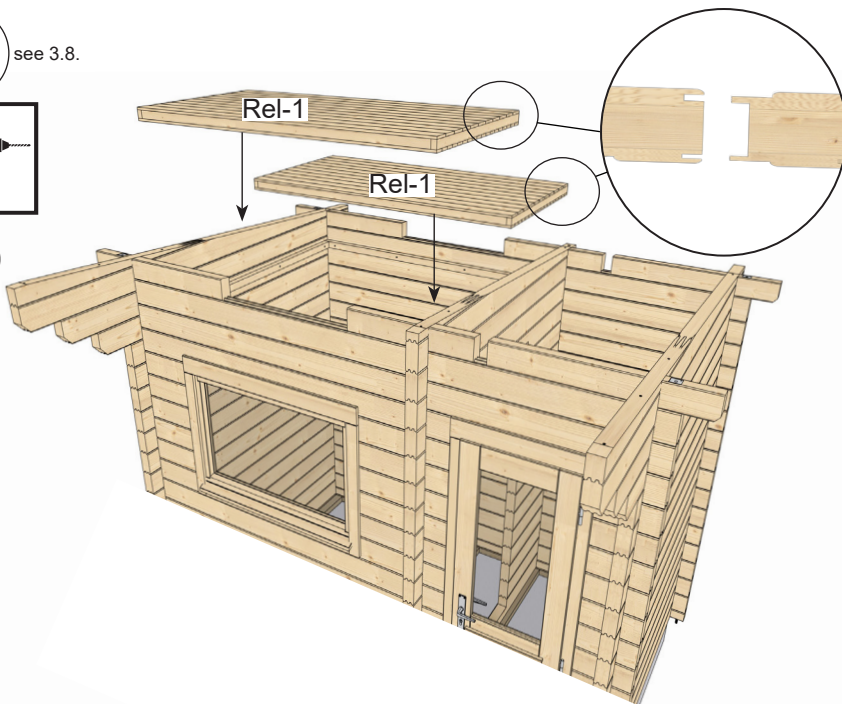

3.9.

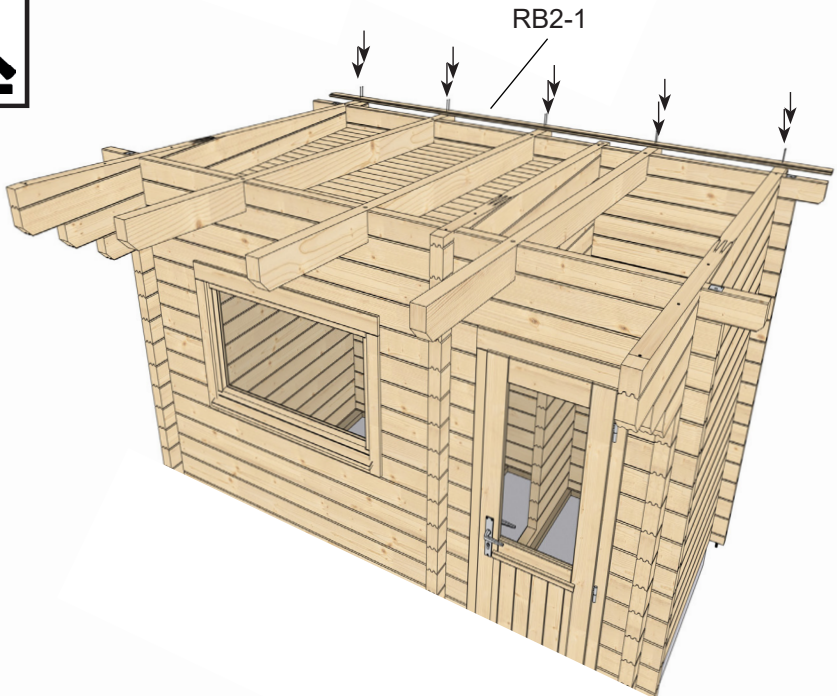
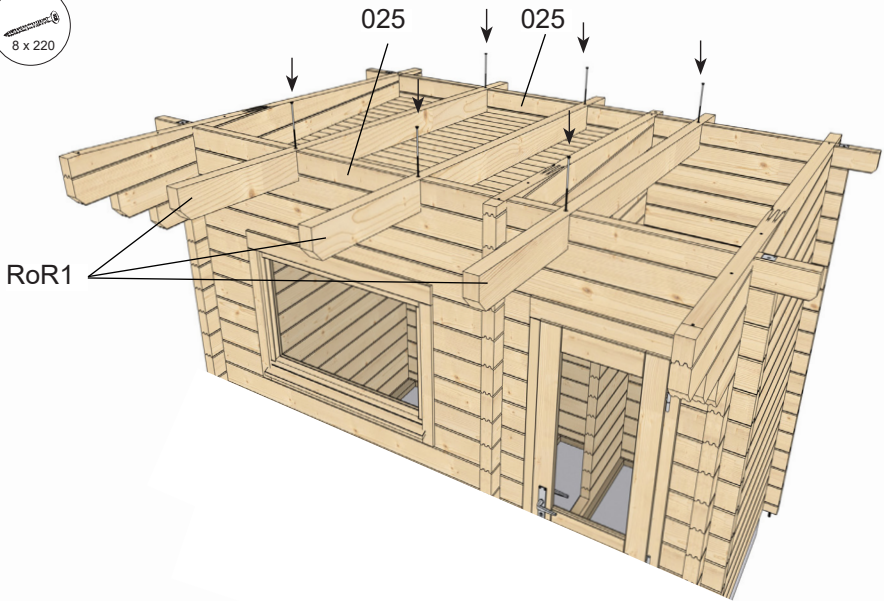

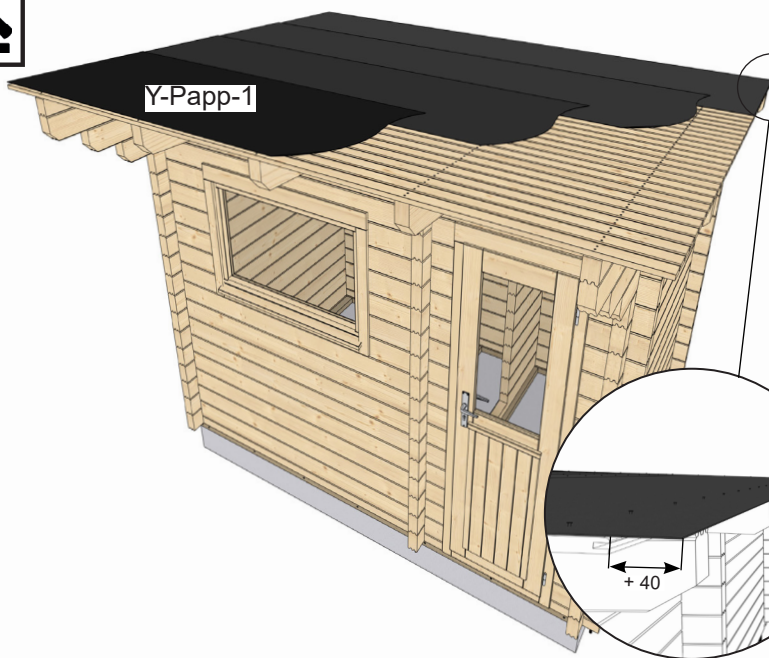
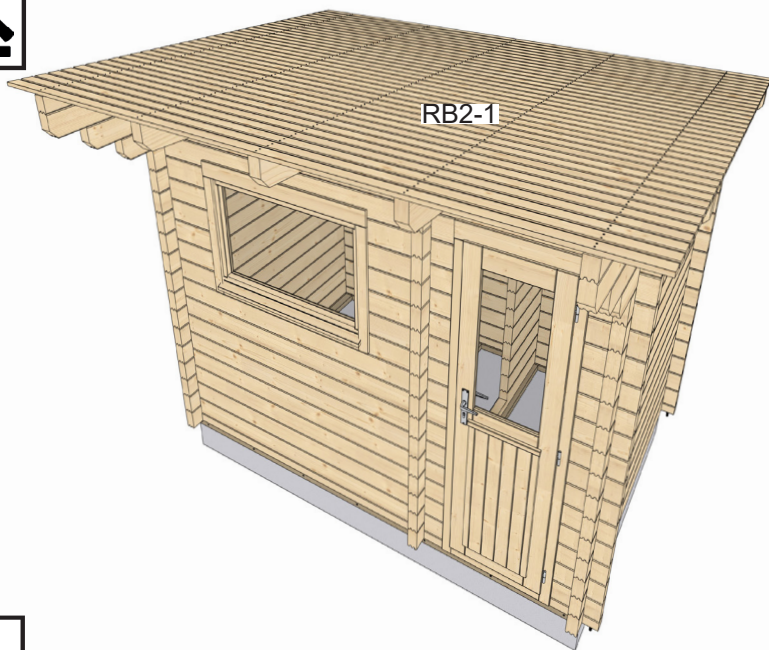

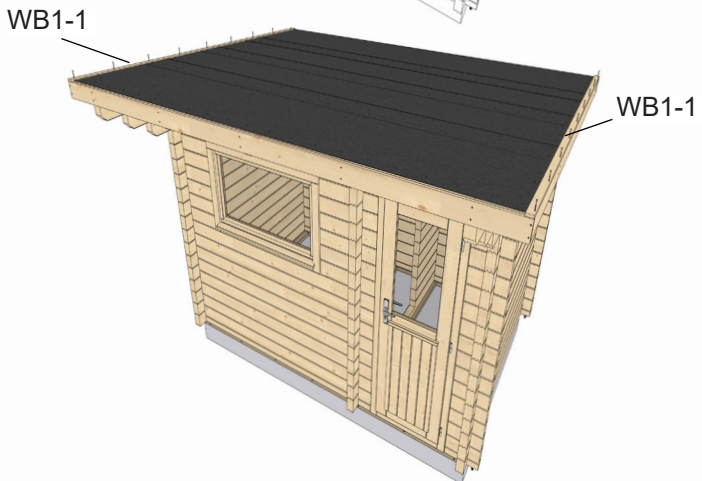
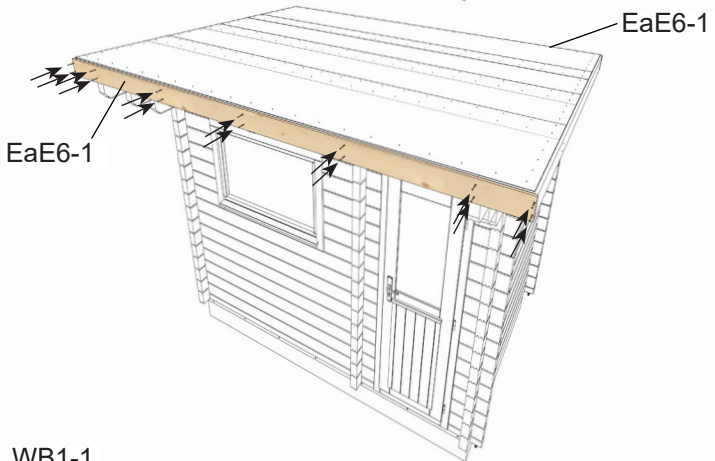
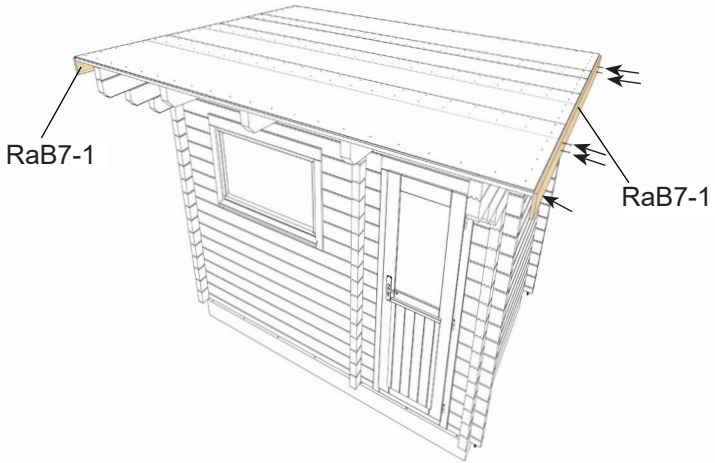

3.10.

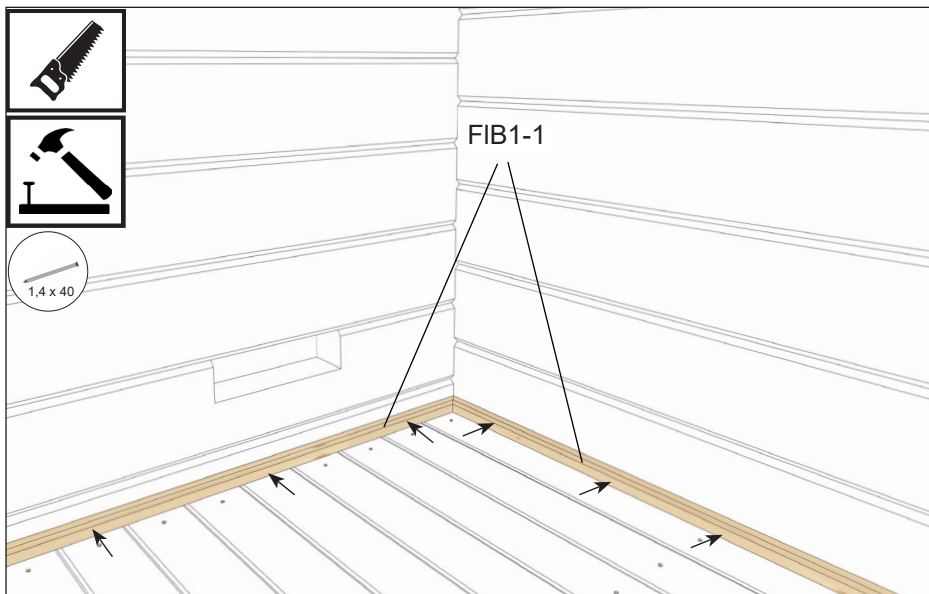
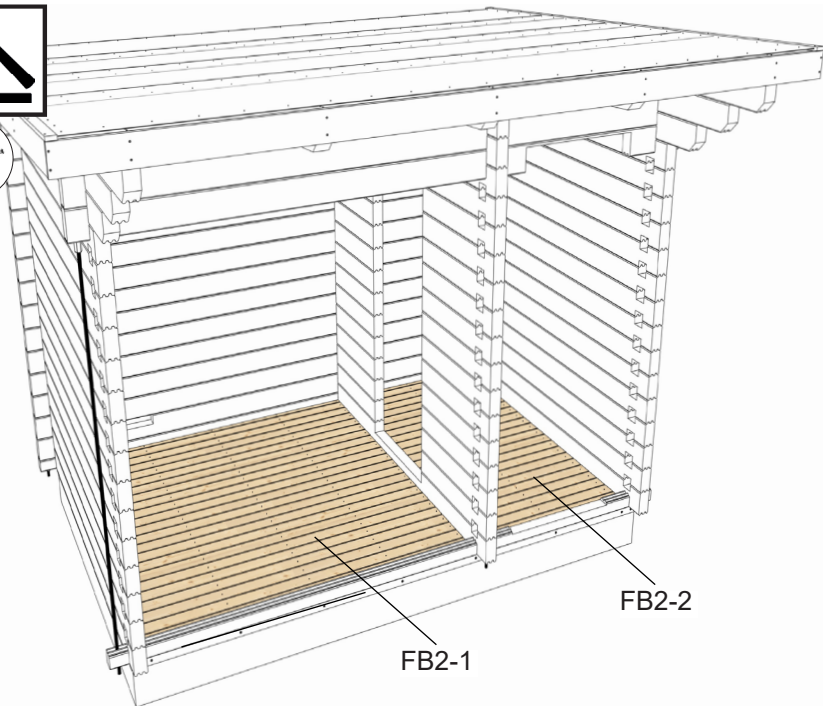

3.11.

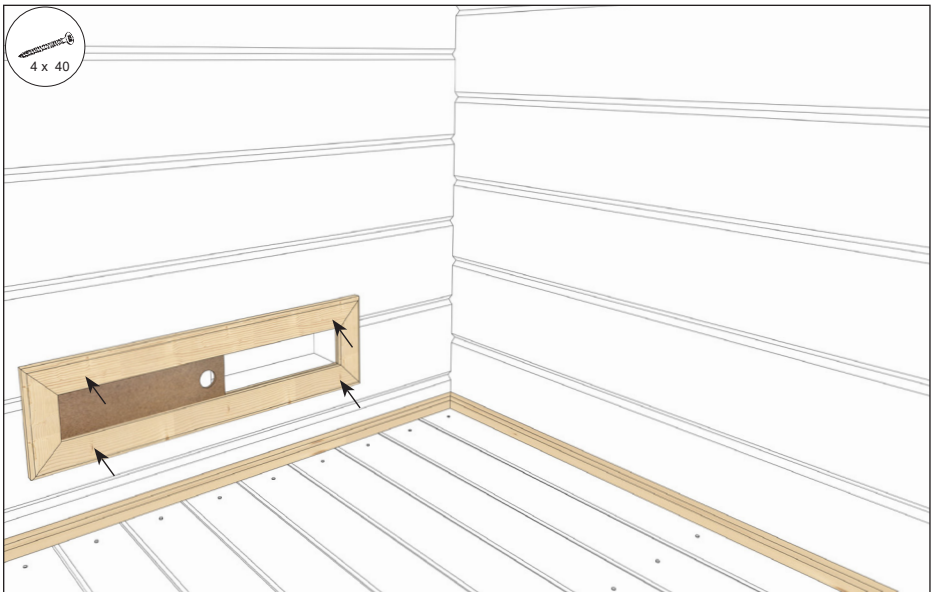
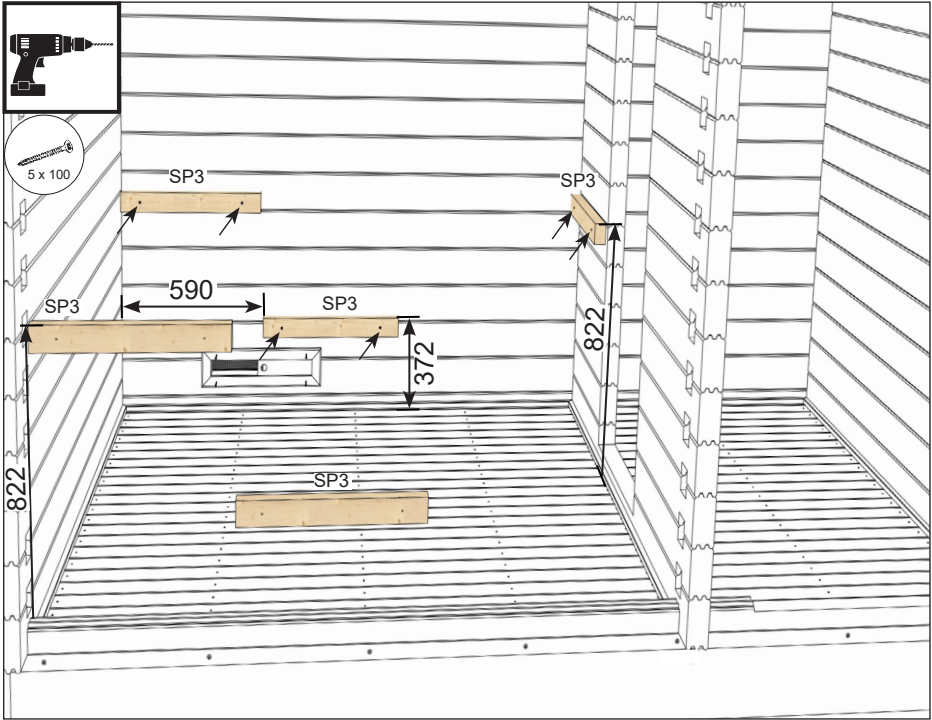

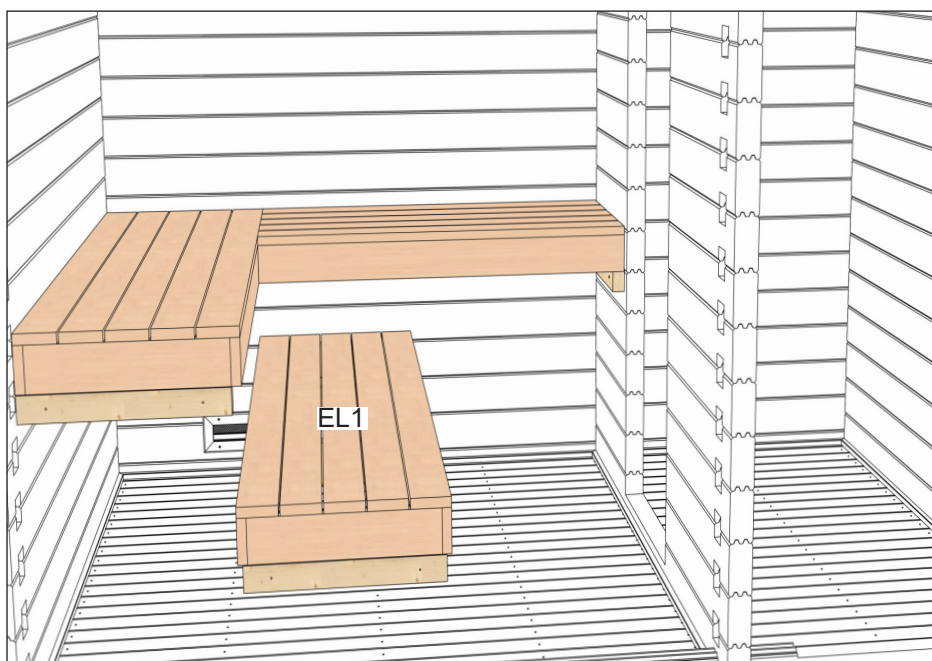
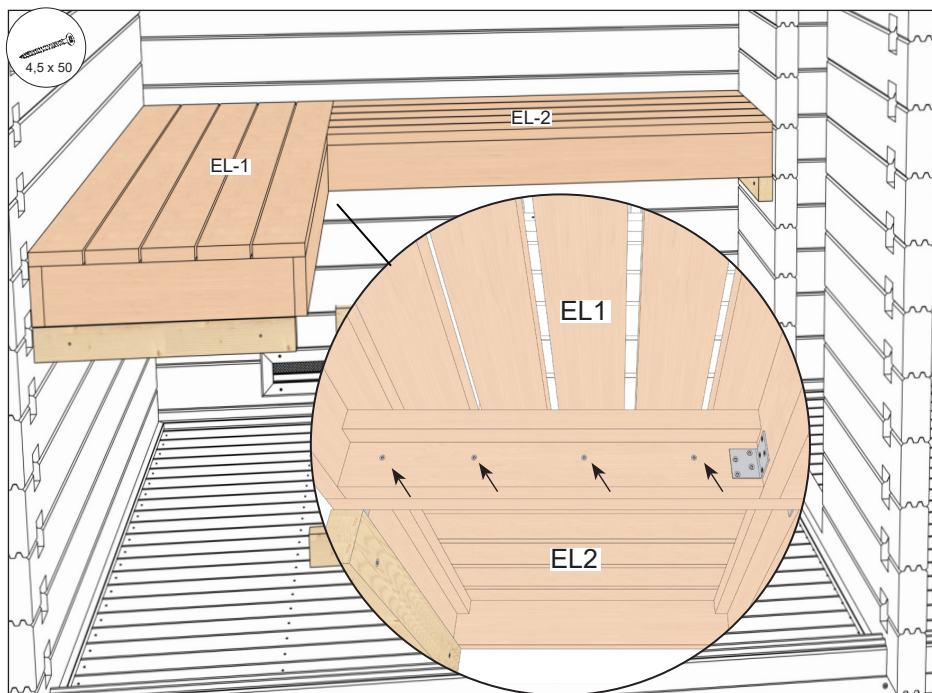

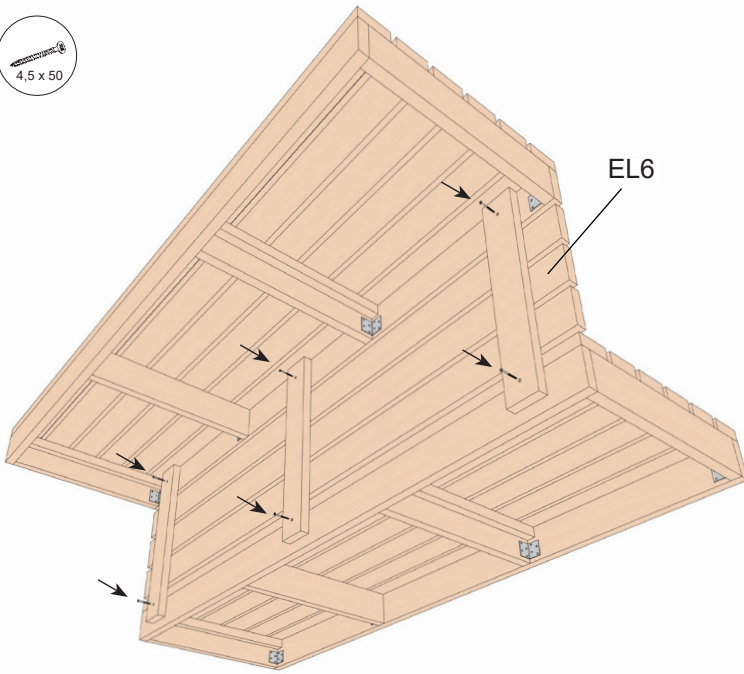

EL6

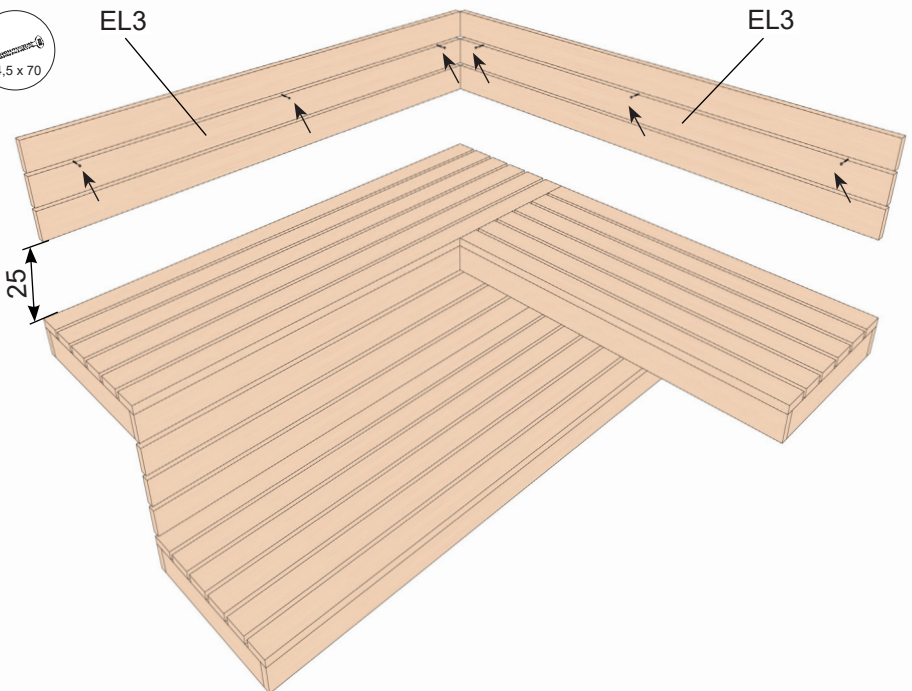

EL3

EL3

25

3.12.

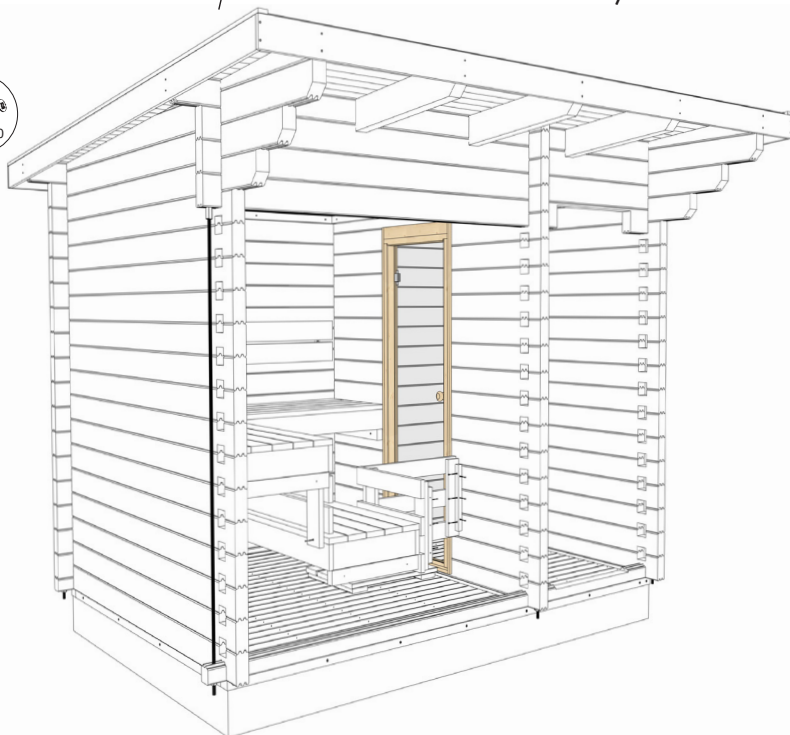
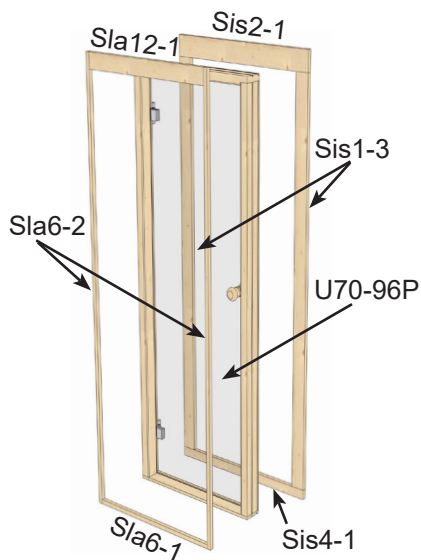
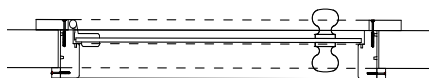
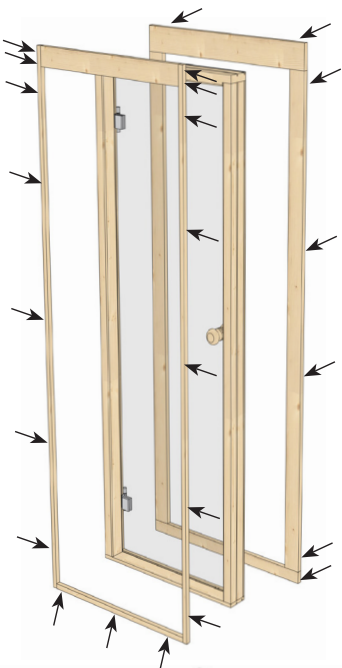

3.13.

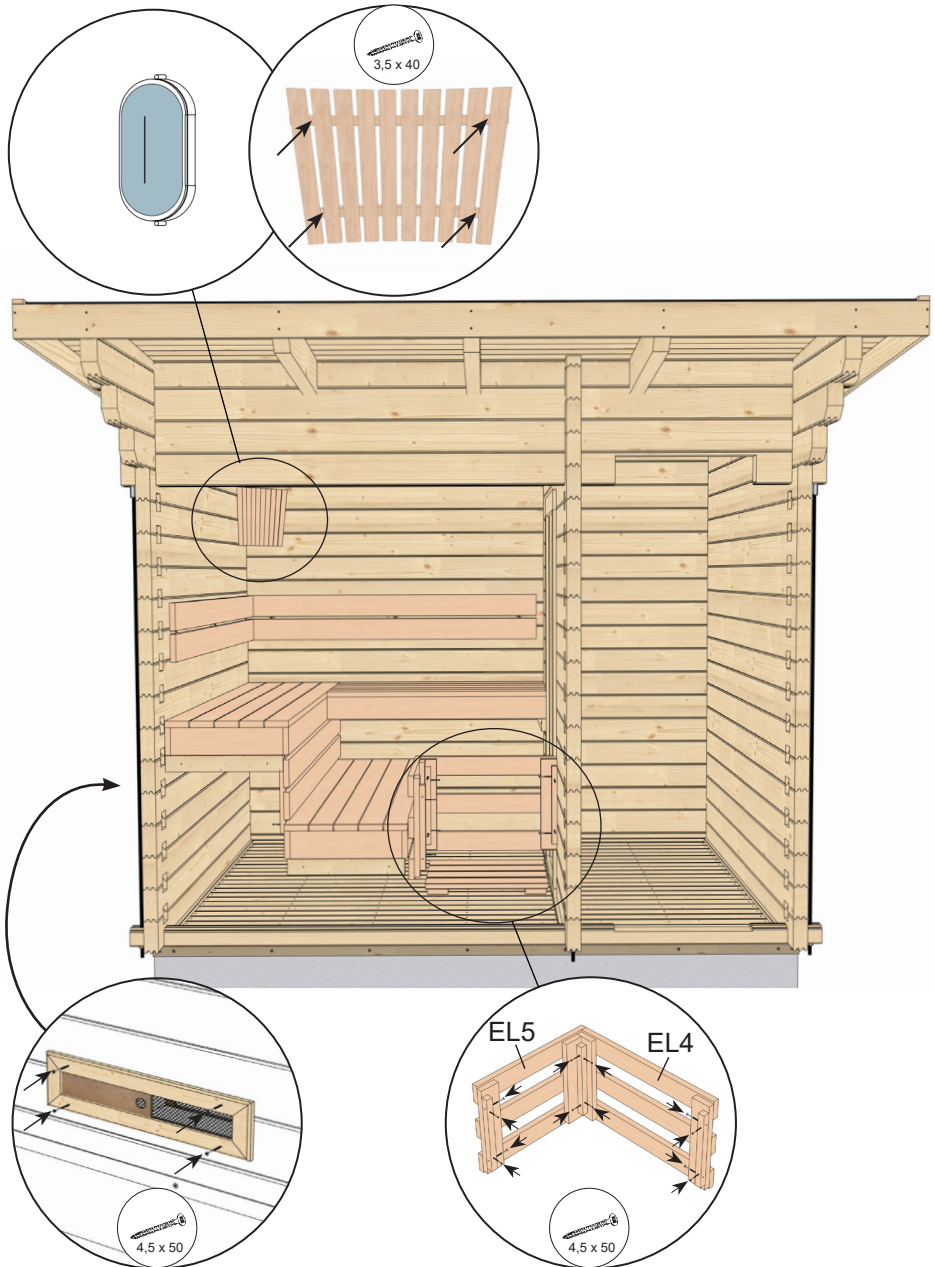



sentiotec GmbH | Division of Harvia Group | Wartenburger Straße 31, A-4840 Vöcklabruck
T +43 (0) 7672/22 900-50 | F -80 | info@sentiotec.com | www.sentiotec.com